



HARA 20
seu próximo desejo 26



Na Hara, cada detalhe nasce com um propósito: gerar valor de verdade.

Desenvolvemos produtos que combinam beleza, funcionalidade e a essência do design brasileiro, pensados para encantar o consumidor final e, ao mesmo tempo, impulsionar os resultados de lojistas e profissionais do setor.

| | |
|-------------------|-----|
| MAIS VENDIDOS | 4 |
| LANÇAMENTOS | 32 |
| BANDEJAS DE METAL | 82 |
| COURO ECOLÓGICO | 114 |
| ACRÍLICO | 124 |
| BANHO | 158 |
| ÁGATA | 168 |
| FONDUE | 176 |
| OUTLET | 184 |

MAIS VENDIDOS







BIA

6

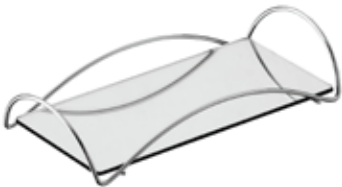

Bandeja Bia Cromada
ref. 1665
Ø11 @21,5

| | cor | tamanho | referência | código de barras |
|--|-----------------|-------------|------------|------------------|
|  | cromado * | Ø11 ㊦21,5 | 1665 | 7899283514396 |
| | | Ø16,5 ㊦26,5 | 1666 | 7899283514426 |
|  | golden ** | Ø11 ㊦21,5 | 1665.10 | 7899283514402 |
| | | Ø16,5 ㊦26,5 | 1666.10 | 7899283514433 |
|  | black matte *** | Ø11 ㊦21,5 | 1665.20 | 7899283514419 |
| | | Ø16,5 ㊦26,5 | 1666.20 | 7899283514440 |

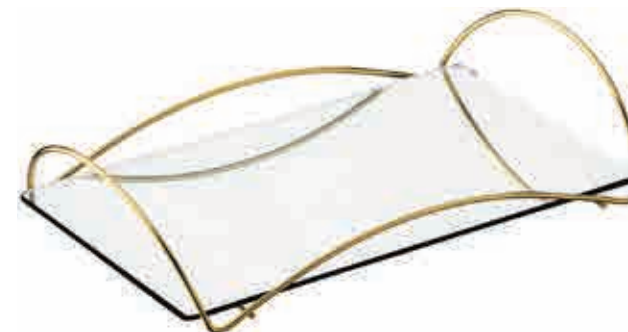

Bandeja Bia
 espelho
 aramado cromado *
 verniz cataforese **
 pintura automotiva ***
 embalagem para presente
caixa master 4 un. (Ø11 ㊦21,5)
caixa master 4 un. (Ø16,5 ㊦26,5)

FENCE ORGÂNICA

8



Bandeja Fence Orgânica Cromada Espelhada
ref. 1604
Ø17 29 4

FENCE ORGÂNICA

| | cor | tamanho | referência | código de barras |
|--|-----------------|------------------|------------|------------------|
|  | cromada * | ∅17 ∅29 14 | 1604 | 7899283517038 |
| | | ∅23 ∅41 14 | 1605 | 7899283517076 |
| | | ∅33 ∅59 14 | 1606 | 7899283517175 |
|  | dourada ** | ∅17 ∅29 14 | 1604.10 | 7899283517045 |
| | | ∅23 ∅41 14 | 1605.10 | 7899283517083 |
| | | ∅33 ∅59 14 | 1606.10 | 7899283517182 |
|  | black matte *** | ∅17 ∅29 14 | 1604.20 | 7899283517052 |
| | | ∅23 ∅41 14 | 1605.20 | 7899283517151 |
| | | ∅33 ∅59 14 | 1606.20 | 7899283517199 |
|  | champagne *** | ∅17 ∅29 14 | 1604.26 | 7899283517069 |
| | | ∅23 ∅41 14 | 1605.26 | 7899283517168 |
| | | ∅33 ∅59 14 | 1606.26 | 7899283517205 |



Bandeja Fence Orgânica Espelhada

base espelhada
 aramado cromado *
 verniz cataforese **
 pintura líquida ***
 embalagem caixa parda
 caixa master 4 un.

FENCE ORGÂNICA

10

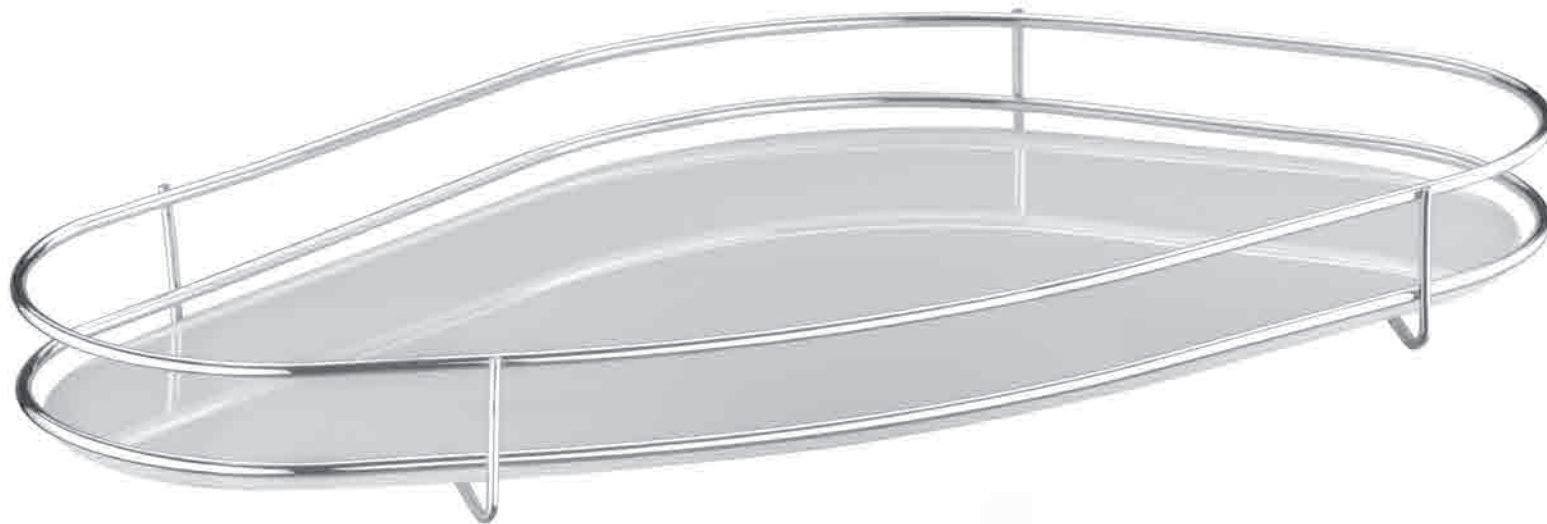

Bandeja Fence Orgânica Cromada Vidro Branco
ref. 1605.21
∅17 ∅29 ∅4

FENCE ORGÂNICA

| | cor | tamanho | referência | código de barras |
|--|---------------------------------------|------------------|------------|------------------|
|  | cromada * com vidro branco | Ø17 ⊞29 Ⓜ4 | 1604.21 | 7899283518646 |
| | | Ø23 ⊞41 Ⓜ4 | 1605.21 | 7899283518653 |
| | | Ø33 ⊞59 Ⓜ4 | 1606.21 | 7899283518660 |
|  | dourada ** com vidro branco | Ø17 ⊞29 Ⓜ4 | 1604.121 | 7899283518677 |
| | | Ø23 ⊞41 Ⓜ4 | 1605.121 | 7899283518684 |
| | | Ø33 ⊞59 Ⓜ4 | 1606.121 | 7899283518691 |
|  | black matte *** com vidro preto | Ø17 ⊞29 Ⓜ4 | 1604.2020 | 7899283518615 |
| | | Ø23 ⊞41 Ⓜ4 | 1605.2020 | 7899283518622 |
| | | Ø33 ⊞59 Ⓜ4 | 1606.2020 | 7899283518639 |

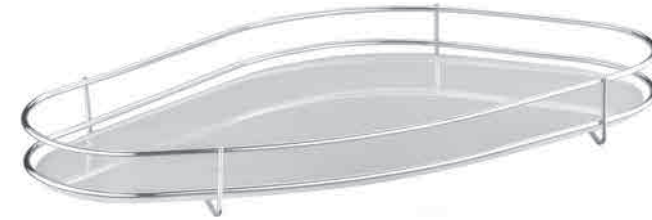

Bandeja Fence Orgânica Vidro

base de vidro
aramado cromado *
verniz cataforese **
pintura líquida ***
embalagem caixa parda
caixa master 4 un.

FENCE

12



Bandeja Fence Golden
ref. 1601.10 • Ø10 20

FENCE



13

Bandeja Fence Cromada
ref. 1602 • @15 @25

FENCE

14



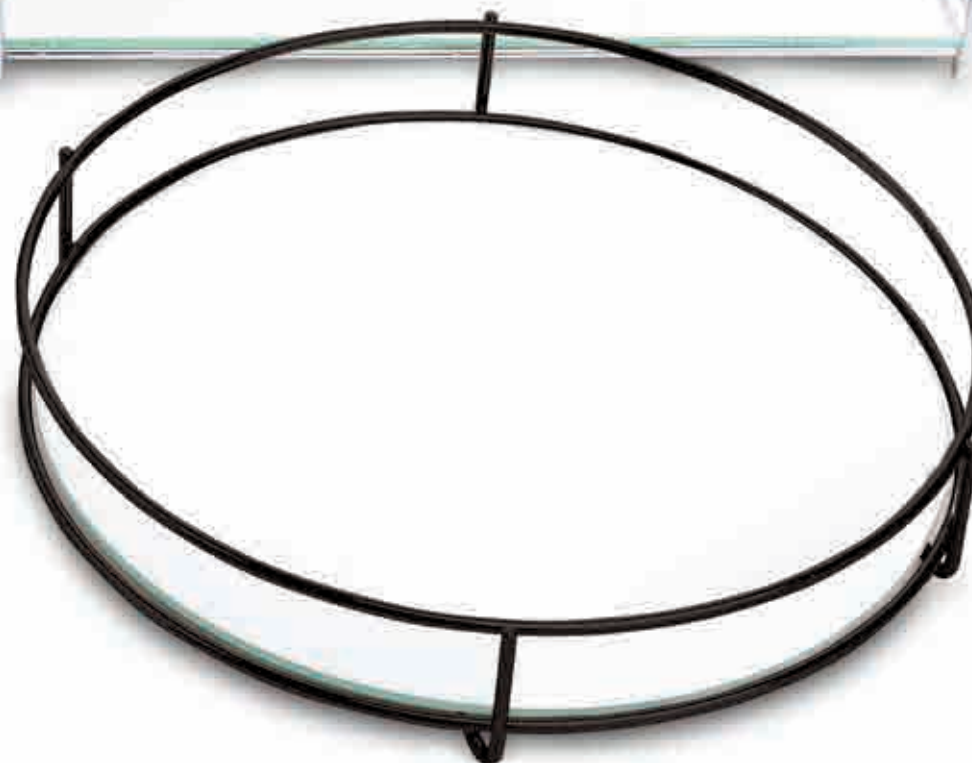

Bandeja Fence Cromada
ref. 1600 · Ø10 10



Bandeja Fence Black Matte
ref. 1603.20 · Ø20

FENCE

| | modelo | tamanho | referência | código de barras |
|--|-----------------|---------------|------------|------------------|
|  | cromada * | ∅10 @10 | 1600 | 7899283507381 |
| | | ∅10 @20 | 1601 | 7899283507428 |
| | | ∅15 @25 | 1602 | 7899283507404 |
| | | ∅20 (redonda) | 1603 | 7899283507367 |
|  | golden ** | ∅10 @10 | 1600.10 | 7899283507374 |
| | | ∅10 @20 | 1601.10 | 7899283507411 |
| | | ∅15 @25 | 1602.10 | 7899283507398 |
| | | ∅20 (redonda) | 1603.10 | 7899283507312 |
|  | black matte *** | ∅10 @10 | 1600.20 | 7899283510060 |
| | | ∅10 @20 | 1601.20 | 7899283510077 |
| | | ∅15 @25 | 1602.20 | 7899283510084 |
| | | ∅20 (redonda) | 1603.20 | 7899283510091 |
|  | champagne *** | ∅10 @10 | 1600.26 | 7899283512972 |
| | | ∅10 @20 | 1601.26 | 7899283512996 |
| | | ∅15 @25 | 1602.26 | 7899283513016 |
| | | ∅20 (redonda) | 1603.26 | 7899283513030 |

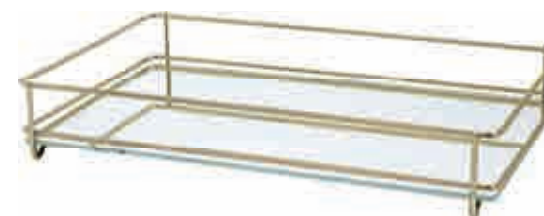

Bandeja Fence

espelho
 aramado cromado *
 verniz cataforese **
 pintura automotiva ***
 embalagem para presente
 caixa master 6 un. (∅10 @10)
 caixa master 6 un. (∅10 @20)
 caixa master 4 un. (∅15 @25)
 caixa master 6 un. (@20)

AYLA

16



Bandeja Ayla Oval Dourada
ref. 1690.10
Ø30,5 455 116

| | cor | tamanho | referência | código de barras |
|--|-----------------|--------------------|------------|------------------|
|  | cromada * | ∅30,5 ∅55 ∅6 | 1690 | 7899283517212 |
| | | ∅21,5 ∅38 ∅6 | 1691 | 7899283518134 |
| | | ∅14 ∅33 ∅6 | 1692 | 7899283518172 |
|  | dourada ** | ∅30,5 ∅55 ∅6 | 1690.10 | 7899283517229 |
| | | ∅21,5 ∅38 ∅6 | 1691.10 | 7899283518141 |
| | | ∅14 ∅33 ∅6 | 1692.10 | 7899283518189 |
|  | black matte *** | ∅30,5 ∅55 ∅6 | 1690.20 | 7899283517236 |
| | | ∅21,5 ∅38 ∅6 | 1691.20 | 7899283518158 |
| | | ∅14 ∅33 ∅6 | 1692.20 | 7899283518196 |

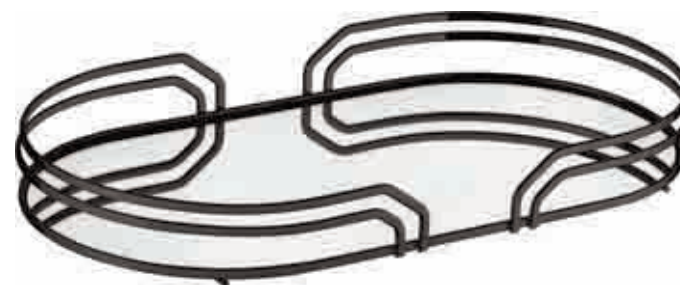

Bandeja Ayla

piatina + base espelhada
 aramado cromado *
 verniz cataforese **
 pintura líquida ***
 embalagem caixa parda
caixa master 4 un.

AYLA

18



Bandeja Ayla Oval Dourada Vidro Branco
ref. 1692.121
Ø14 33 06

| | cor | tamanho | referência | código de barras |
|--|---------------------------------------|--------------------|------------|------------------|
|  | cromada * com vidro branco | ∅30,5 ∅55 ∅6 | 1690.21 | 7899283518707 |
| | | ∅21,5 ∅38 ∅6 | 1691.21 | 7899283518714 |
| | | ∅14 ∅33 ∅6 | 1692.21 | 7899283518721 |
|  | dourada ** com vidro branco | ∅30,5 ∅55 ∅6 | 1690.121 | 7899283518738 |
| | | ∅21,5 ∅38 ∅6 | 1691.121 | 7899283518745 |
| | | ∅14 ∅33 ∅6 | 1692.121 | 7899283518752 |
|  | black matte *** com vidro preto | ∅30,5 ∅55 ∅6 | 1690.2020 | 7899283518769 |
| | | ∅21,5 ∅38 ∅6 | 1691.2020 | 7899283518776 |
| | | ∅14 ∅33 ∅6 | 1692.2020 | 7899283518578 |



Bandeja Ayla
 piatina + base de vidro
 aramado cromado *
 verniz cataforese **
 pintura líquida ***
 embalagem caixa parda
caixa master 4 un.

VASO SOLITÁRIO

20



**Vaso Solitário
Retangular**

ref. 5946
Ø3 03 018



**Vaso Solitário
Retangular**

ref. 5945
Ø3 03 013

VASO SOLITÁRIO

| | modelo | tamanho | espessura acrílico (mm) | referência | código de barras |
|---|------------|-----------|-------------------------|------------|------------------|
|  | Retangular | ∅3 13 | 40 | 5945 | 7899283515478 |
| | | ∅3 18 | | 5946 | 7899283515485 |
|  | Sextavado | ∅13 15 | | 5947 | 7899283515492 |
|  | Redondo | ∅12 12 | 30 | 5948 | 7899283515508 |
| | | ∅16 16 | | 5949 | 7899283515515 |



Vaso Solitário Retangular

vaso em acrílico cristal
material 100% virgem
embalagem em caixa parda
caixa master 4 un.

ORGÂNICA

22



Bandeja Orgânica
ref. 1761
24 29 02

ORGÂNICA

| | tamanho | espessura acrílico (mm) | referência | código de barras |
|--|------------|-------------------------|------------|------------------|
|  | ∅15 ∅18 | | 1760 | 7899283515263 |
|  | ∅24 ∅29 | 6 | 1761 | 7899283515270 |
|  | ∅34 ∅40 | | 1762 | 7899283515287 |
|  | ∅44 ∅52 | 8 | 1763 | 7899283515522 |



Bandeja Orgânica
bandeja em acrílico cristal
material 100% virgem
embalagem em caixa parda
caixa master 4 un.

DOBRADA BAIXA



24

Bandeja Dobrada Baixa
ref. 1718
☐24 ☐35 ☐3,5

DOBRADA BAIXA

| tamanho | espessura acrílico (mm) | referência | código de barras |
|---------------------|-------------------------|------------|------------------|
| Ø10 ⊖35 Ⓜ 3,5 | 4 | 1715 | 7899283515010 |
| Ø12 ⊖25 Ⓜ 3,5 | | 1716 | 7899283515027 |
| Ø20 ⊖20 Ⓜ 3,5 | | 1717 | 7899283515034 |
| Ø24 ⊖35 Ⓜ 3,5 | | 1718 | 7899283515041 |



Bandeja Dobrada Baixa

bandeja em acrílico cristal
material 100% virgem
embalagem em caixa parda
caixa master 4 un.

DIAMANTADA

26

Bandeja Diamantada
ref. 1703
☐33 ☐42

DIAMANTADA

| tamanho | espessura acrílico (mm) | referência | código de barras |
|------------|-------------------------|------------|------------------|
| ∅12 □25 | 20 | 1700 | 7899283514921 |
| ∅20 □30 | | 1701 | 7899283514938 |
| ∅33 □33 | | 1702 | 7899283514945 |
| ∅33 □42 | | 1703 | 7899283514952 |



Bandeja Diamantada





bandeja em acrílico cristal
material 100% virgem
embalagem em caixa parda
caixa master 4 un.

ARCO

28

Suporte para Toalha Arco Golden
ref. 5913.10 • 14.5 14 41.5



| | cor | tamanho | referência | código de barras |
|---|-----------------|-----------------|------------|------------------|
|  | cromado * | Ø14,5 □14 □41,5 | 5913 | 7899283509682 |
|  | golden ** | | 5913.10 | 7899283509378 |
|  | black matte *** | | 5913.20 | 7899283505950 |
|  | champagne *** | | 5913.26 | 7899283513573 |



Suporte para Toalha Arco

aramado cromado *
verniz cataforese **
pintura automotiva ***
caixa master 4 un.

DUO

30



**Suporte para Toalha
Duo Black Matte**
ref. 5916.20 • 10 20 30

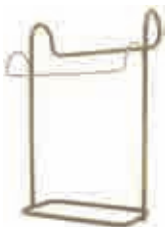

**Suporte para Toalha
Duo Cromado**
ref. 5916 • 10 20 30

| | cor | tamanho | referência | código de barras |
|---|-----------------|-------------|------------|------------------|
|  | cromado * | | 5916 | 7899283506858 |
|  | golden ** | | 5916.10 | 7899283506575 |
| | | ∅10 ∅20 ∅30 | | |
|  | black matte *** | | 5916.20 | 7899283510053 |
|  | champagne *** | | 5916.26 | 7899283513603 |



Suporte para Toalhas Duo

aramado cromado *
verniz cataforese **
pintura automotiva ***
caixa master 4 un.

LANÇAMENTOS







FLOW ACRÍLICO

34

Bandeja Flow Acrílico
ref. 1783
Ø27,7 39,5 13

Bandeja Flow Acrílico
ref. 1782
Ø21,5 29 12

FLOW ACRÍLICO

| | tamanho | referência | código de barras |
|---|--|------------|------------------|
|  | Ø21,5 ⊖29 ⊖12 Altura Interna: 2 cm Espessura: 6 mm | 1782 | 7899283519049 |
|  | Ø27,7 ⊖39,5 ⊖13 Altura Interna: 3 cm Espessura: 6 mm | 1783 | 7899283519056 |



Bandeja Flow Acrílico
base de acrílico 6 mm incolor
embalagem caixa parda
caixa master 4 un.











TEMÁTICA

36



Bandeja Temática Libélula Dourada
ref. 1790.174
☐30 ☐26.3 ☐3

TEMÁTICA

| | modelo | espessura (mm) | tamanho | referência | código de barras |
|---|------------------------|----------------|----------------------|------------|------------------|
|  | borboleta dourada | 8 | Ø30 □26,3 □3 | 1790.170 | 7899283519001 |
|  | abelha dourada | | | 1790.172 | 7899283519582 |
|  | patinha dourada | | | 1790.173 | 7899283519599 |
|  | libélula dourada | | | 1790.174 | 7899283519605 |
|  | pug dourado | 8 | Ø35,5 □31,2 □3 | 1791.171 | 7899283519018 |
|  | coelho dourado | | | 1791.175 | 7899283519612 |
|  | foguete cromado | | | 1791.76 | 7899283519643 |
|  | timão dourado | | | 1791.177 | 7899283519629 |
|  | cavalo marinho dourado | | | 1791.178 | 7899283519636 |
|  | osso cromado | | | 1791.79 | 7899283519650 |
|  | astronauta cromado | | | 1791.80 | 7899283520007 |



Bandeja Temática
base de acrílico 8 mm incolor
embalagem caixa parda
caixa master 4 un.





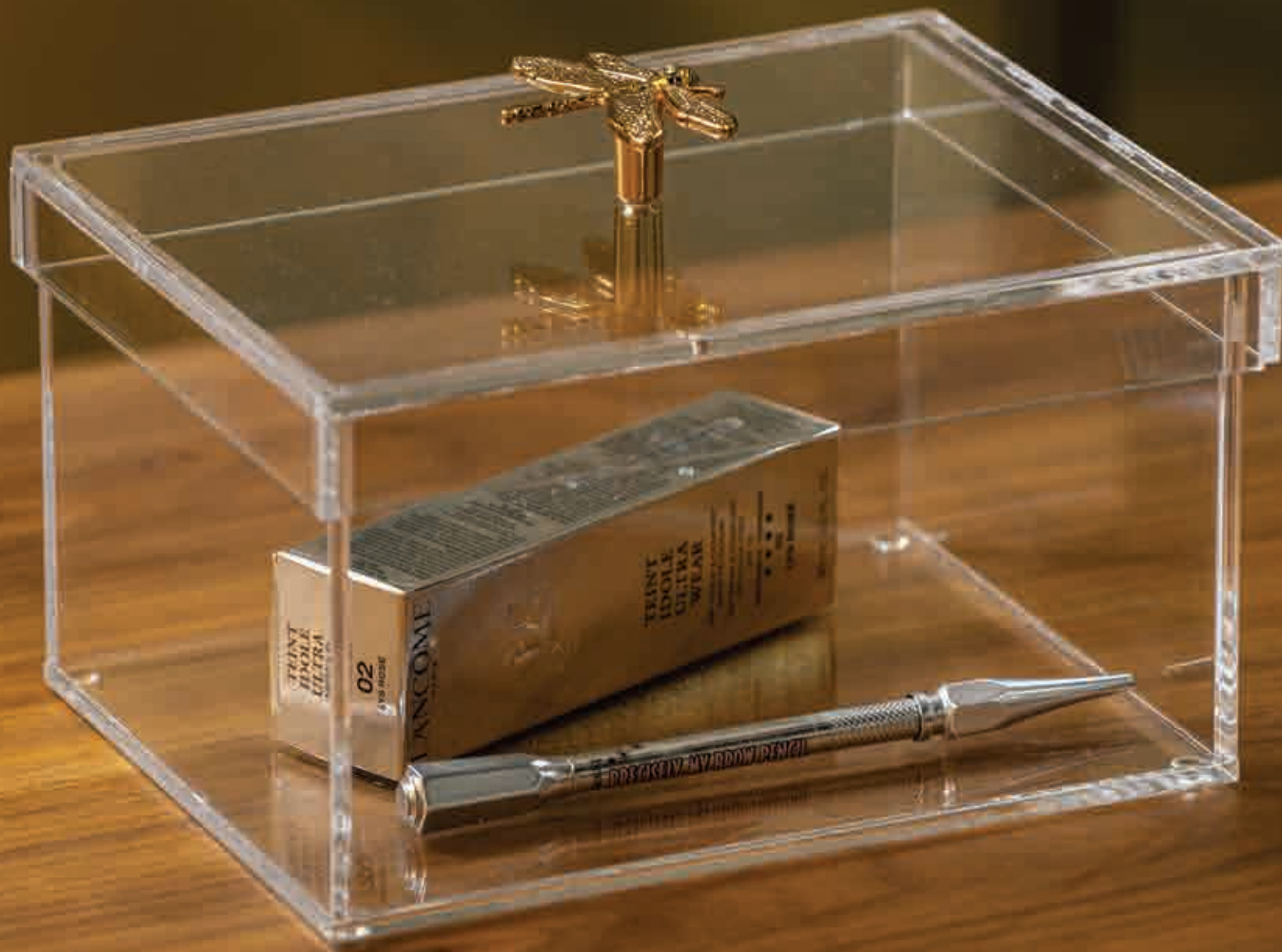





TEMÁTICA

38



Caixa Organizadora Temática Libélula Dourada
ref. 5931.174
Ø16 621 013

TEMÁTICA

| | modelo | espessura (mm) | tamanho | referência | código de barras |
|---|------------------------|----------------|-------------------|------------|------------------|
|  | borboleta dourada | 4 | Ø16 E21 E13 | 5931.170 | 7899283519568 |
|  | abelha dourada | | | 5931.172 | 7899283519667 |
|  | patinha dourada | | | 5931.173 | 7899283519674 |
|  | libélula dourada | | | 5931.174 | 7899283519681 |
|  | pug dourado | 4 | Ø16 E26 E13 | 5932.171 | 7899283519575 |
|  | coelho dourado | | | 5932.175 | 7899283519698 |
|  | foguete cromado | | | 5932.76 | 7899283519728 |
|  | timão dourado | | | 5932.177 | 7899283519704 |
|  | cavalo marinho dourado | | | 5932.178 | 7899283519711 |
|  | osso cromado | | | 5932.79 | 7899283519735 |
|  | astronauta cromado | | | 5932.80 | 7899283520014 |

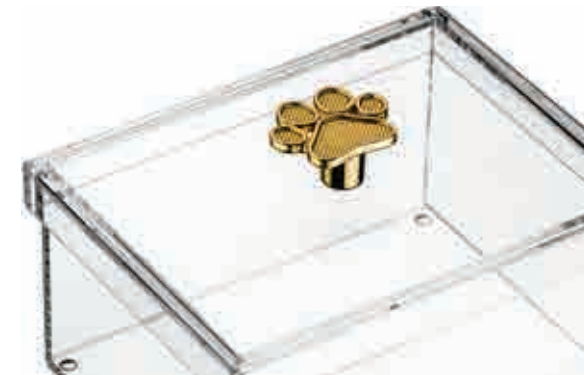

Caixa Organizadora Temática
base de acrílico 4 mm incolor
embalagem caixa parda
caixa master 4 un.

ALÍCIA

40



Bandeja Alícia
ref. 1794
218 138 103

Bandeja Alícia
ref. 1795
230 160 103

| | tamanho | referência | código de barras |
|--|----------------|------------|------------------|
|  | Ø18 38 3 | 1794 | 7899283519506 |
|  | Ø30 60 3 | 1795 | 7899283519513 |



Bandeja Alícia
 base de acrílico 8 mm incolor
 embalagem caixa parda
 caixa master 4 un.

LOLA

42

Bandeja Lola
ref. 1798
∅30 ∅42 ∅2,5



Bandeja Lola

base de acrílico 8 mm incolor
alças em madeira
embalagem caixa parda
caixa master 4 un.

| tamanho | espessura acrílico (mm) | referência | código de barras |
|--------------------|-------------------------|------------|------------------|
| ∅12 ∅30 ∅2,5 | 8 | 1797 | 7899283520229 |
| ∅30 ∅42 ∅2,5 | 8 | 1798 | 7899283519520 |



Bandeja Lola Ice

base de acrílico 8 mm texturizado
alças em madeira
embalagem caixa parda
caixa master 4 un.

| tamanho | espessura acrílico (mm) | referência | código de barras |
|--------------------|-------------------------|------------|------------------|
| Ø12 □30 □2,5 | 8 | 1797.48 | 7899283520236 |
| Ø30 □42 □2,5 | 8 | 1798.48 | 7899283520243 |



ICE

44

Bandeja Ice
ref. 1744
Ø13 Ø25,5 H4

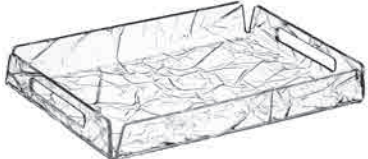

| | tamanho | referência | código de barras |
|--|--------------------|------------|------------------|
|  | Ø13 ⊖25,5 ⊕4 | 1744 | 7899283519971 |
|  | Ø21 ⊖30,5 ⊕4 | 1745 | 7899283519988 |
|  | Ø24 ⊖36 ⊕4 | 1746 | 7899283519995 |

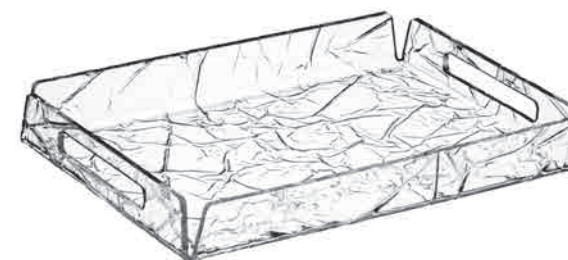

Bandeja Ice



base de acrílico texturizado 4 mm incolor
 embalagem caixa parda
caixa master 4 un.

SLIM

46

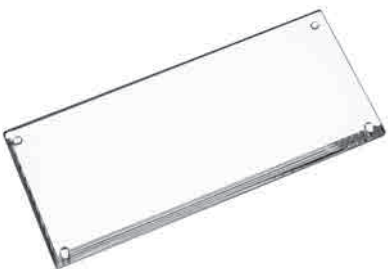

Bandeja Slim Acrílico
ref. 1768
Ø10 20 06

| | tamanho | referência | código de barras |
|--|----------------|------------|------------------|
|  | Ø10 20 6 | 1768 | 7899283519032 |
|  | Ø12 30 6 | 1769 | 7899283519025 |
|  | Ø20 30 6 | 1767 | 7899283520205 |
|  | Ø30 50 6 | 1766 | 7899283520212 |



Bandeja Slim Acrílico
 base de acrílico 6 mm incolor
 embalagem caixa parda
 caixa master 4 un.



SLIM



48

Vaso Solitário Slim
ref. 5955
∅2 12 9

Vaso Solitário Slim
ref. 5956
∅2 15 11

| | tamanho | referência | código de barras |
|--|----------------|------------|------------------|
|  | Ø2 9 12 | 5955 | 7899283519469 |
|  | Ø2 11 15 | 5956 | 7899283519476 |





Vaso Solitário Slim Acrílico
 base de acrílico 20 mm incolor
 embalagem caixa parda
 caixa master 4 un.

VASO SOLITÁRIO TORCIDO

50

Vaso Solitário Torcido
ref. 5957
Ø5 66 115

VASO SOLITÁRIO TORCIDO

| | tamanho | referência | código de barras |
|--|-----------------|------------|------------------|
|  | ∅5 ∅6 ∅15 | 5957 | 7899283519483 |
|  | ∅5 ∅6 ∅18 | 5958 | 7899283519490 |



Vaso Solitário Torcido
base de acrílico 8 mm incolor
embalagem caixa parda
caixa master 4 un.



VASO ASSIMÉTRICO

52

Vaso Assimétrico
ref. 5960
∅9 89 125

Vaso Assimétrico
ref. 5959
∅9 89 120

VASO ASSIMÉTRICO

| | tamanho | referência | código de barras |
|--|-----------------|------------|------------------|
|  | ∅9 ∅9 H20 | 5959 | 7899283519766 |
|  | ∅9 ∅9 H25 | 5960 | 7899283519759 |

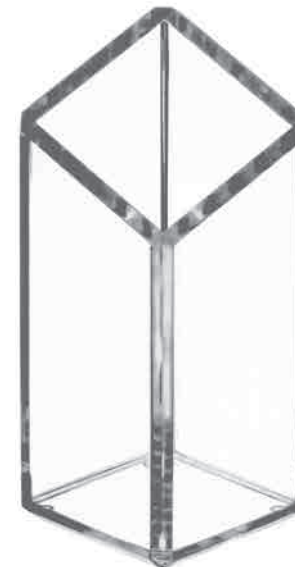

Vaso Assimétrico
base de acrílico 8 mm incolor
embalagem caixa parda
caixa master 4 un.

PORTA TOALHA

54



Porta Toalha
ref. 5894
□12 □20 □30



Porta Toalha

base de acrílico 8 mm incolor
embalagem caixa parda
caixa master 4 un.

| tamanho | espessura acrílico (mm) | referência | código de barras |
|-------------------|-------------------------|------------|------------------|
| □12 □20 □30 | 8 | 5894 | 7899283519544 |

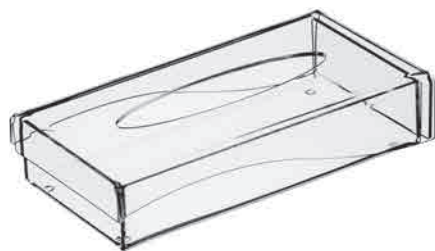

Porta Lenços Acrílico

base de acrílico 3 mm incolor
 embalagem caixa parda
 caixa master 4 un.

| tamanho | espessura acrílico (mm) | referência | código de barras |
|------------------|-------------------------|------------|------------------|
| Ø13 25,5 6 | 3 | 5980 | 7899283519551 |



Porta Lenços Acrílico Preto

base de acrílico 3 mm incolor
 embalagem caixa parda
 caixa master 4 un.

| tamanho | espessura acrílico (mm) | referência | código de barras |
|------------------|-------------------------|------------|------------------|
| Ø13 25,5 6 | 3 | 5980.20 | 7899283520335 |

PORTA LENÇOS

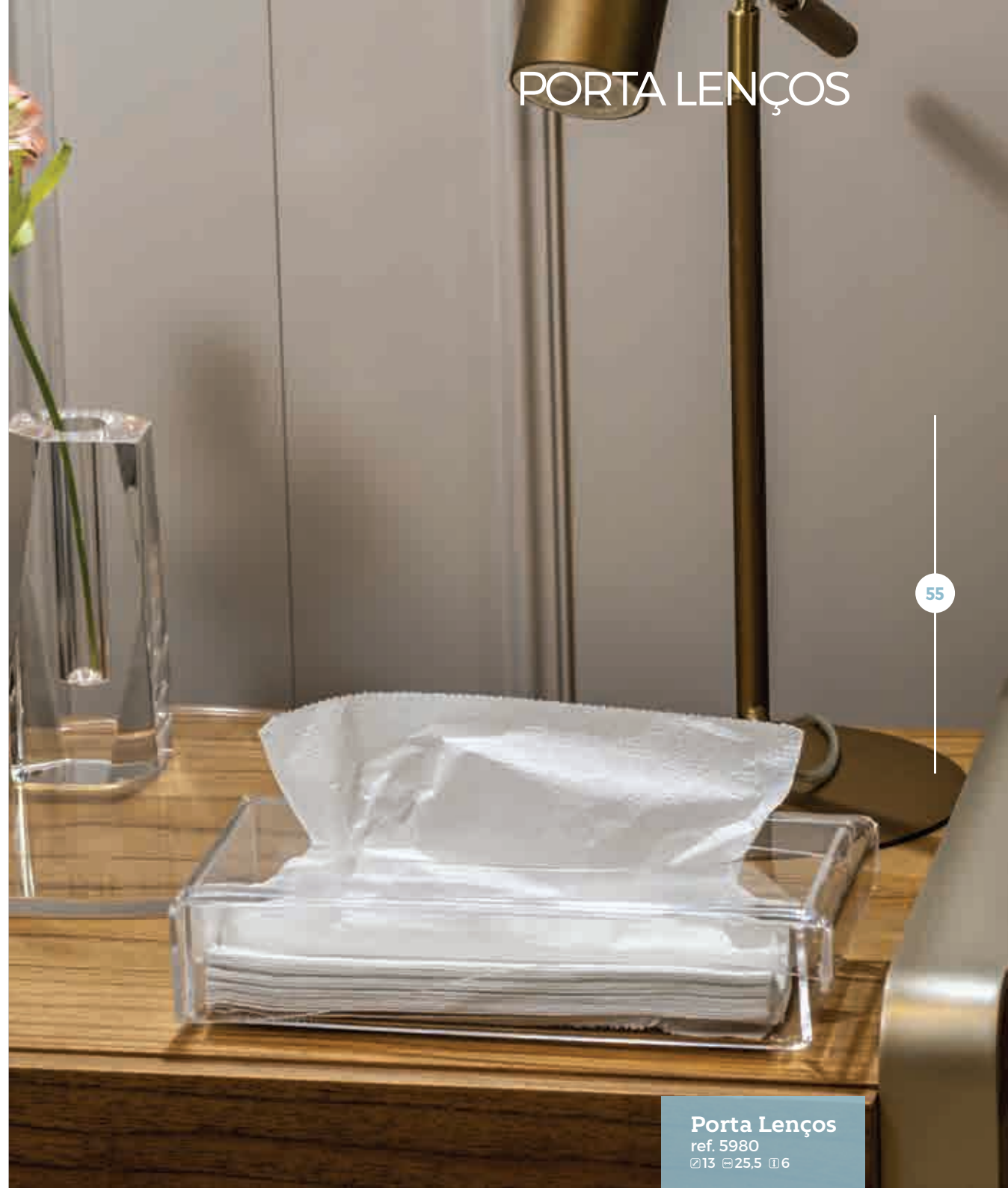

PORTA RETRATO

56



Porta Retrato Acrílico Premium com Imã
ref. 5985
24 12 17

PORTA RETRATO

| | tamanho | referência | código de barras |
|--|----------------|------------|------------------|
|  | ∅4 12 17 | 5985 | 7899283519537 |
|  | ∅4 17 22 | 5986 | 7899283519742 |



Porta Retrato Acrílico Premium com Imã

base de acrílico incolor
embalagem caixa parda
caixa master 4 un.

GOTA

58

Bandeja Gota Acrílico
ref. 1785
Ø19 629 01

| | cor | tamanho | referência | código de barras |
|--|--------------|----------------------|------------|------------------|
|  | acrílico | Ø19 ☒29 ☒1 | 1785 | 7899283518981 |
| | | Ø24,5 ☒38,5 ☒1 | 1786 | 7899283518998 |
|  | branca | Ø18,5 ☒30 ☒8 | 1830.21 | 7899283518882 |
| | | Ø24,5 ☒39,5 ☒1 | 1831.21 | 7899283518936 |
|  | preta | Ø18,5 ☒30 ☒1 | 1830.40 | 7899283518899 |
| | | Ø24,5 ☒39,5 ☒1 | 1831.40 | 7899283518943 |
|  | bege | Ø18,5 ☒30 ☒1 | 1830.51 | 7899283518905 |
| | | Ø24,5 ☒39,5 ☒1 | 1831.51 | 7899283518950 |
|  | caramelo | Ø18,5 ☒30 ☒1 | 1830.52 | 7899283518912 |
| | | Ø24,5 ☒39,5 ☒1 | 1831.52 | 7899283518967 |
|  | verde sálvia | Ø18,5 ☒30 ☒1 | 1830.54 | 7899283518929 |
| | | Ø24,5 ☒39,5 ☒1 | 1831.54 | 7899283518974 |



Bandeja Gota
base de acrílico / couro ecológico
embalagem caixa parda
caixa master 4 un.

ISIS COURO ECOLÓGICO

60



Bandeja Isis Couro Ecológico Verde Sálvia
ref. 1838.54
∅29.5 ∅49.5 ∅3.5

ISIS COURO ECOLÓGICO

| | cor | tamanho | referência | código de barras |
|--|--------------|------------------------|------------|------------------|
|  | branca | ☐29,5 ☐29,5 ☐3,5 | 1837.21 | 7899283519162 |
| | | ☐29,5 ☐49,5 ☐3,5 | 1838.21 | 7899283519216 |
|  | preta | ☐29,5 ☐29,5 ☐3,5 | 1837.40 | 7899283519179 |
| | | ☐29,5 ☐49,5 ☐3,5 | 1838.40 | 7899283519223 |
|  | bege | ☐29,5 ☐29,5 ☐3,5 | 1837.51 | 7899283519186 |
| | | ☐29,5 ☐49,5 ☐3,5 | 1838.51 | 7899283519230 |
|  | caramelo | ☐29,5 ☐29,5 ☐3,5 | 1837.52 | 7899283519193 |
| | | ☐29,5 ☐49,5 ☐3,5 | 1838.52 | 7899283519247 |
|  | verde sálvia | ☐29,5 ☐29,5 ☐3,5 | 1837.54 | 7899283519209 |
| | | ☐29,5 ☐49,5 ☐3,5 | 1838.54 | 7899283519254 |



Bandeja Isis Couro Ecológico

base de couro ecológico
embalagem caixa parda
caixa master 4 un.

MEL COURO ECOLÓGICO

62



Bandeja Mel Couro Ecológico Branca
ref. 1826.21
☐34,5 ☐59,5 ☐2

MEL COURO ECOLÓGICO

| | cor | tamanho | referência | código de barras |
|--|--------------|----------------------|------------|------------------|
|  | branco | ☐34,5 ☐39,5 ☐2 | 1825.21 | 7899283518783 |
| | | ☐34,5 ☐59,5 ☐2 | 1826.21 | 7899283518837 |
|  | preto | ☐34,5 ☐39,5 ☐2 | 1825.40 | 7899283518790 |
| | | ☐34,5 ☐59,5 ☐2 | 1826.40 | 7899283518844 |
|  | bege | ☐34,5 ☐39,5 ☐2 | 1825.51 | 7899283518806 |
| | | ☐34,5 ☐59,5 ☐2 | 1826.51 | 7899283518851 |
|  | caramelo | ☐34,5 ☐39,5 ☐2 | 1825.52 | 7899283518813 |
| | | ☐34,5 ☐59,5 ☐2 | 1826.52 | 7899283518875 |
|  | verde sálvia | ☐34,5 ☐39,5 ☐2 | 1825.54 | 7899283518820 |
| | | ☐34,5 ☐59,5 ☐2 | 1826.54 | 7899283518875 |



Bandeja Mel Couro Ecológico
base de couro ecológico
embalagem caixa parda
caixa master 4 un.

GAIA COURO ECOLÓGICO MELAMINA

64



Bandeja Gaia Couro Ecológico Branco Melamina Marmorizada
ref. 1835.21
Ø30 40 05

GAIA COURO ECOLÓGICO MELAMINA

| | cor | tamanho | referência | código de barras |
|--|--|------------------|------------|------------------|
|  | branca + base melamina marmorizada | ∅30 ⊞40 Ⓜ5 | 1835.21 | 7899283519087 |
| | | ∅40 ⊞60 Ⓜ5 | 1836.21 | 7899283519124 |
|  | preta + base melamina | ∅30 ⊞40 Ⓜ5 | 1835.40 | 7899283519094 |
| | | ∅40 ⊞60 Ⓜ5 | 1836.40 | 7899283519131 |
|  | bege + base melamina | ∅30 ⊞40 Ⓜ5 | 1835.51 | 7899283519100 |
| | | ∅40 ⊞60 Ⓜ5 | 1836.51 | 7899283519148 |
|  | caramelo + base melamina | ∅30 ⊞40 Ⓜ5 | 1835.52 | 7899283519117 |
| | | ∅40 ⊞60 Ⓜ5 | 1836.52 | 7899283519155 |



Bandeja Gaia Couro Ecológico Melamina
base de couro ecológico + base melamina
embalagem caixa parda
caixa master 4 un.





CLARA COURO ECOLÓGICO MELAMINA

66



Bandeja Clara Couro Ecológico Bege Base Melamina
ref. 1818.51
☐30 ☐40 ☐1

CLARA COURO ECOLÓGICO MELAMINA

| | cor | tamanho | referência | código de barras |
|--|--|------------------|------------|------------------|
|  | branca + base melamina marmorizada | ∅30 ∅40 11 | 1818.21 | 7899283519308 |
|  | preta + base melamina | ∅30 ∅40 11 | 1818.40 | 7899283519315 |
|  | bege + base melamina | ∅30 ∅40 11 | 1818.51 | 7899283519322 |
|  | caramelo + base melamina | ∅30 ∅40 11 | 1818.52 | 7899283519339 |







Bandeja Clara Couro Ecológico Melamina
base de couro ecológico + base melamina
embalagem caixa parda
caixa master 4 un.

NAIA

68



Bandeja Naia Black Matte Vidro Preto
ref. 1295.2020
Ø21,5 x 37 x 5

| | cor | modelo | tamanho | referência | código de barras | |
|--|--------------------|--------------------|--------------------|--------------------|------------------|---------------|
|  | cromada * | espelhada | ∅21,5 ∅37 ∅5 | 1295 | 7899283519346 | |
| | | | ∅29,5 ∅55 ∅5 | 1296 | 7899283519407 | |
| vidro branco | | ∅21,5 ∅37 ∅5 | 1295.21 | 7899283519391 | | |
| | | ∅29,5 ∅55 ∅5 | 1296.21 | 7899283519452 | | |
|  | | dourada ** | espelhada | ∅21,5 ∅37 ∅5 | 1295.10 | 7899283519353 |
| | | | | ∅29,5 ∅55 ∅5 | 1296.10 | 7899283519414 |
| vidro branco | ∅21,5 ∅37 ∅5 | | 1295.121 | 7899283519360 | | |
| | ∅29,5 ∅55 ∅5 | | 1296.121 | 7899283519438 | | |
|  | black matte *** | | espelhada | ∅21,5 ∅37 ∅5 | 1295.20 | 7899283519377 |
| | | | | ∅29,5 ∅55 ∅5 | 1296.20 | 7899283519421 |
| vidro preto | | ∅21,5 ∅37 ∅5 | 1295.2020 | 7899283519384 | | |
| | | ∅29,5 ∅55 ∅5 | 1296.2020 | 7899283519445 | | |
|  | | | | | | |





Bandeja Naia
 base espelhada ou de vidro
 aramado cromado *
 verniz cataforese **
 pintura líquida ***
 embalagem caixa parda
caixa master 4 un.

FOLHA

70

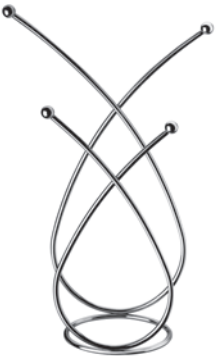
Suporte para Toalha Folha Dourado
ref. 589710
011 022 034

| | cor | tamanho | referência | código de barras |
|---|-----------------|-------------------|------------|------------------|
|  | cromada * | Ø11 Ø22 Ø34 | 5897 | 7899283519070 |
|  | dourada ** | Ø11 Ø22 Ø34 | 5897.10 | 7899283519285 |
|  | black matte *** | Ø11 Ø22 Ø34 | 5897.20 | 7899283519292 |

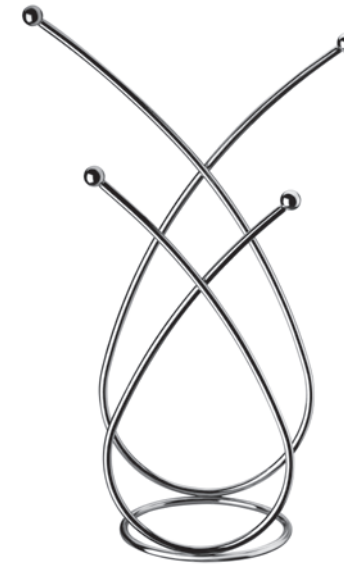

Suporte para Toalha Folha



aramado cromado *
 verniz cataforese **
 pintura líquida ***
 embalagem caixa parda
 caixa master 4 un.

LÍNEA

72



Suporte para Toalha Línea Cromado
ref. 5899
Ø75 617 027

| | cor | tamanho | referência | código de barras |
|---|-----------------|---|------------|------------------|
|  | cromada * | \varnothing 7,5 \varnothing 17 \varnothing 27 | 5899 | 7899283519063 |
|  | dourada ** | \varnothing 7,5 \varnothing 17 \varnothing 27 | 5899.10 | 7899283519261 |
|  | black matte *** | \varnothing 7,5 \varnothing 17 \varnothing 27 | 5899.20 | 7899283519278 |

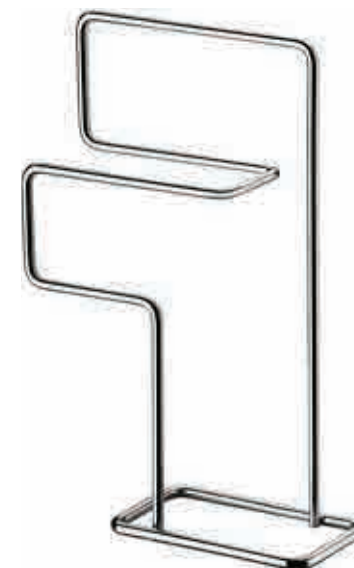

Suporte para Toalha Línea

aramado cromado *
 verniz cataforese **
 pintura líquida ***
 embalagem caixa parda
 caixa master 4 un.



PORTA TOALHAS

74

Porta Toalhas Dourado Pirita
ref. 7008.145
Ø10 @25 @35



PORTA TOALHAS

| | haste | modelo | tamanho | referência | código de barras |
|--|------------|--------|-------------------|------------|------------------|
|  | cromado * | pirita | Ø10 Ø25 Ø35 | 7008.45 | 7899283519858 |
|  | dourado ** | pirita | Ø10 Ø25 Ø35 | 7008.145 | 7899283519865 |



Porta Toalhas

esculpido a partir de pedras naturais
 aramado cromado *
 verniz cataforese **
 embalagem caixa parda
caixa master 2 un.









PORTA TOALHAS

76

Porta Toalhas Cromado Obsidiana Preto
ref. 7008.40
Ø10 25 35



PORTA TOALHAS

| | haste | modelo | tamanho | referência | código de barras |
|---|------------|-----------------|-------------------|------------|------------------|
|  | cromado * | quartzo branco | Ø10 ⊗25 Ⓜ35 | 7008 | 7899283519773 |
|  | | obsidiana preto | | 7008.40 | 7899283519827 |
|  | | quartzo verde | | 7008.43 | 7899283519834 |
|  | | quartzo rosa | | 7008.44 | 7899283519841 |
|  | dourado ** | quartzo branco | Ø10 ⊗25 Ⓜ35 | 7008.10 | 7899283519780 |
|  | | obsidiana preto | | 7008.140 | 7899283519797 |
|  | | quartzo verde | | 7008.143 | 7899283519803 |
|  | | quartzo rosa | | 7008.144 | 7899283519810 |



Porta Toalhas

esculpido a partir de pedras naturais
 aramado cromado *
 verniz cataforese **
 embalagem caixa parda
caixa master 2 un.

*Por se tratar de um produto em pedra natural, podem ocorrer pequenas variações de medida, cor e textura, tornando cada peça única.











PORTA PAPEL

78

Porta Papel Dourado Pirita
ref. 7009.145
Ø10 21 53

Porta Papel Cromado Obsidiana Preto
ref. 7009.40
Ø10 21 53

PORTA PAPEL

| | haste | modelo | tamanho | referência | código de barras |
|---|------------|-----------------|-------------------|------------|------------------|
|  | cromado * | quartzo branco | Ø10 ⊕21 Ⓜ53 | 7009 | 7899283519872 |
|  | | obsidiana preto | | 7009.40 | 7899283519933 |
|  | | quartzo verde | | 7009.43 | 7899283519940 |
|  | | quartzo rosa | | 7009.44 | 7899283519957 |
|  | | pirita | | 7009.45 | 7899283519964 |
|  | dourado ** | quartzo branco | Ø10 ⊕21 Ⓜ53 | 7009.10 | 7899283519889 |
|  | | obsidiana preto | | 7009.140 | 7899283519896 |
|  | | quartzo verde | | 7009.143 | 7899283519902 |
|  | | quartzo rosa | | 7009.144 | 7899283519919 |
|  | | pirita | | 7009.145 | 7899283519926 |



Porta Papel

esculpido a partir de pedras naturais
 aramado cromado *
 verniz cataforese **
 embalagem caixa parda
caixa master 2 un.

*Por se tratar de um produto em pedra natural, podem ocorrer pequenas variações de medida, cor e textura, tornando cada peça única.

OLIVA

80

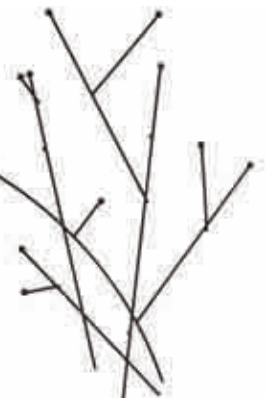

Cabideiro Decorativo de Parede Oliva Cromado
ref. 1058
📏 📐 📏

| | cor | tamanho | referência | código de barras |
|---|-----------------|----------------|------------|------------------|
|  | cromado * | Ø? ⊖? Ⓜ? | 1058 | 7899283520281 |
|  | dourado ** | Ø? ⊖? Ⓜ? | 1058.10 | 7899283520298 |
|  | black matte *** | Ø? ⊖? Ⓜ? | 1058.20 | 7899283520274 |

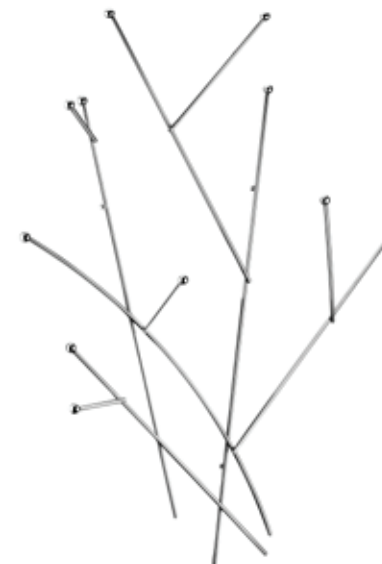

Cabideiro Decorativo de Parede Oliva

aramado cromado *
verniz cataforese **
pintura líquida ***
embalagem caixa parda
caixa master 4 un.





BANDEJAS DE METAL

CELINE

84



Bandeja Celine Dourada
ref. 1696.10
37 58 6

CELINE

| | cor | tamanho | referência | código de barras |
|--|-----------------|--------------------|------------|------------------|
|  | cromada * | ☐22 ☐32,5 Ⓜ6 | 1694 | 7899283517915 |
| | | ☐30 ☐41 Ⓜ6 | 1695 | 7899283517953 |
| | | ☐37 ☐58 Ⓜ6 | 1696 | 7899283517267 |
|  | dourada ** | ☐22 ☐32,5 Ⓜ6 | 1694.10 | 7899283517922 |
| | | ☐30 ☐41 Ⓜ6 | 1695.10 | 7899283517960 |
| | | ☐37 ☐58 Ⓜ6 | 1696.10 | 7899283517274 |
|  | black matte *** | ☐22 ☐32,5 Ⓜ6 | 1694.20 | 7899283517939 |
| | | ☐30 ☐41 Ⓜ6 | 1695.20 | 7899283517977 |
| | | ☐37 ☐58 Ⓜ6 | 1696.20 | 7899283517281 |
|  | champagne *** | ☐22 ☐32,5 Ⓜ6 | 1694.26 | 7899283517946 |
| | | ☐30 ☐41 Ⓜ6 | 1695.26 | 7899283517984 |
| | | ☐37 ☐58 Ⓜ6 | 1696.26 | 7899283517298 |



Bandeja Celine
 piatina + base espelhada
 aramado cromado *
 verniz cataforese **
 pintura líquida ***
 embalagem caixa parda
caixa master 4 un.

LUANA

86



Bandeja Luana Cromada
ref. 1642
☐30 ☐40 ☐6

LUANA



87





Bandeja Luana Champagne
ref. 1641.26 · 20 30

LUANA

88



Bandeja Luana Golden
ref. 1642.10 • 30 40

| | cor | tamanho | referência | código de barras |
|--|-----------------|-----------|------------|------------------|
|  | cromada * | Ø10 ㊦30 | 1639 | 7899283512507 |
| | | Ø10 ㊦20 | 1640 | 7899283511203 |
| | | Ø20 ㊦30 | 1641 | 7899283511234 |
| | | Ø30 ㊦40 | 1642 | 7899283511258 |
| | | Ø37 ㊦57 | 1643 | 7899283511531 |
| | | Ø39,5 ㊦70 | 1644 | 7899283511548 |
|  | golden ** | Ø10 ㊦30 | 1639.10 | 7899283512491 |
| | | Ø10 ㊦20 | 1640.10 | 7899283511210 |
| | | Ø20 ㊦30 | 1641.10 | 7899283511241 |
| | | Ø30 ㊦40 | 1642.10 | 7899283511272 |
| | | Ø37 ㊦57 | 1643.10 | 7899283511579 |
| | | Ø39,5 ㊦70 | 1644.10 | 7899283511586 |
|  | black matte *** | Ø10 ㊦30 | 1639.20 | 7899283512682 |
| | | Ø10 ㊦20 | 1640.20 | 7899283512699 |
| | | Ø20 ㊦30 | 1641.20 | 7899283512705 |
| | | Ø30 ㊦40 | 1642.20 | 7899283512712 |
| | | Ø37 ㊦57 | 1643.20 | 7899283512729 |
| | | Ø39,5 ㊦70 | 1644.20 | 7899283512736 |
|  | champagne *** | Ø10 ㊦30 | 1639.26 | 7899283513368 |
| | | Ø10 ㊦20 | 1640.26 | 7899283513375 |
| | | Ø20 ㊦30 | 1641.26 | 7899283513382 |
| | | Ø30 ㊦40 | 1642.26 | 7899283513399 |
| | | Ø37 ㊦57 | 1643.26 | 7899283513405 |
| | | Ø39,5 ㊦70 | 1644.26 | 7899283513412 |



Bandeja Luana

espelho

aramado cromado *

verniz cataforese **

pintura automotiva ***

embalagem para presente

caixa master 6 un. (Ø10 ㊦20)

caixa master 6 un. (Ø10 ㊦30)

caixa master 4 un. (Ø20 ㊦30)

caixa master 4 un. (Ø30 ㊦40)

caixa master 2 un. (Ø37 ㊦57)

caixa master 2 un. (Ø39,5 ㊦70)





LUANA TAMPO COURÍSSIMO

90



**Bandeja Luana Tampo Couríssimo Preto
Black Matte**
ref. 1643.240 • 37 57

LUANA TAMPO COURÍSSIMO CAMELO

| | cor | tamanho | referência | código de barras |
|---|-----------------|--------------|------------|------------------|
|  | cromada * | ☒30 ☒40 | 1642.52 | 7899283514365 |
| | | ☒37 ☒57 | 1643.52 | 7899283514051 |
| | | ☒39,5 ☒70 | 1644.52 | 7899283514204 |
|  | golden ** | ☒30 ☒40 | 1642.152 | 7899283513818 |
| | | ☒37 ☒57 | 1643.152 | 7899283514082 |
| | | ☒39,5 ☒70 | 1644.152 | 7899283514235 |
|  | black matte *** | ☒30 ☒40 | 1642.252 | 7899283513870 |
| | | ☒37 ☒57 | 1643.252 | 7899283514112 |
| | | ☒39,5 ☒70 | 1644.252 | 7899283514266 |
|  | champagne *** | ☒30 ☒40 | 1642.2652 | 7899283513900 |
| | | ☒37 ☒57 | 1643.2652 | 7899283514143 |
| | | ☒39,5 ☒70 | 1644.2652 | 7899283514297 |



Bandeja Luana Tampo Couríssimo Caramelo



base revestida em couro ecológico
 aramado cromado *
 verniz cataforese **
 pintura automotiva ***
 embalagem para presente
 caixa master 4 un. (☒30 ☒40)
 caixa master 2 un. (☒37 ☒57)
 caixa master 2 un. (☒39,5 ☒70)

LUANA TAMPO COURÍSSIMO BEGE





Bandeja Luana Tampo Couríssimo Bege

base revestida em couro ecológico
 aramado cromado *
 verniz cataforese **
 pintura automotiva ***
 embalagem para presente
 caixa master 4 un. (∅30 ∅40)
 caixa master 2 un. (∅37 ∅57)
 caixa master 2 un. (∅39,5 ∅70)

| | cor | tamanho | referência | código de barras |
|---|-----------------|--------------|------------|------------------|
|  | cromada * | ∅30 ∅40 | 1642.51 | 7899283514372 |
| | | ∅37 ∅57 | 1643.51 | 7899283514044 |
| | | ∅39,5 ∅70 | 1644.51 | 7899283514198 |
|  | golden ** | ∅30 ∅40 | 1642.151 | 7899283514341 |
| | | ∅37 ∅57 | 1643.151 | 7899283514075 |
| | | ∅39,5 ∅70 | 1644.151 | 7899283514228 |
|  | black matte *** | ∅30 ∅40 | 1642.251 | 7899283513863 |
| | | ∅37 ∅57 | 1643.251 | 7899283514105 |
| | | ∅39,5 ∅70 | 1644.251 | 7899283514259 |
|  | champagne *** | ∅30 ∅40 | 1642.2651 | 7899283513894 |
| | | ∅37 ∅57 | 1643.2651 | 7899283514136 |
| | | ∅39,5 ∅70 | 1644.2651 | 7899283514280 |

LUANA TAMPO COURÍSSIMO PRETO

| | cor | tamanho | referência | código de barras |
|---|-----------------|--------------|------------|------------------|
|  | cromada * | ☒30 ☒40 | 1642.40 | 7899283513979 |
| | | ☒37 ☒57 | 1643.40 | 7899283513719 |
| | | ☒39,5 ☒70 | 1644.40 | 7899283513726 |
|  | golden ** | ☒30 ☒40 | 1642.140 | 7899283513962 |
| | | ☒37 ☒57 | 1643.140 | 7899283513733 |
| | | ☒39,5 ☒70 | 1644.140 | 7899283513740 |
|  | black matte *** | ☒30 ☒40 | 1642.240 | 7899283513955 |
| | | ☒37 ☒57 | 1643.240 | 7899283513757 |
| | | ☒39,5 ☒70 | 1644.240 | 7899283513764 |
|  | champagne *** | ☒30 ☒40 | 1642.2640 | 7899283513948 |
| | | ☒37 ☒57 | 1643.2640 | 7899283513771 |
| | | ☒39,5 ☒70 | 1644.2640 | 7899283513788 |



Bandeja Luana Tampo Couríssimo Preto

base revestida em couro ecológico

aramado cromado *

verniz cataforese **

pintura automotiva ***

embalagem para presente

caixa master 4 un. (☒30 ☒40)

caixa master 2 un. (☒37 ☒57)

caixa master 2 un. (☒39,5 ☒70)

LUIZA RETANGULAR

94



Bandeja Luiza Retangular Golden
ref. 1673.10
Ø31,5 51,5 08,5

LUIZA RETANGULAR

| | cor | tamanho | referência | código de barras |
|---|-----------|---------------------------|------------|------------------|
|  | cromada * | □ 31,5 ▣ 41,5 ⊕ 8,5 | 1672 | 7899283515317 |
|  | | □ 31,5 ▣ 51,5 ⊕ 8,5 | 1673 | 7899283515355 |
|  | | □ 31,5 ▣ 66,5 ⊕ 8,5 | 1674 | 7899283515393 |
|  | golden ** | □ 31,5 ▣ 41,5 ⊕ 8,5 | 1672.10 | 7899283515324 |
|  | | □ 31,5 ▣ 51,5 ⊕ 8,5 | 1673.10 | 7899283515362 |
|  | | □ 31,5 ▣ 66,5 ⊕ 8,5 | 1674.10 | 7899283515409 |

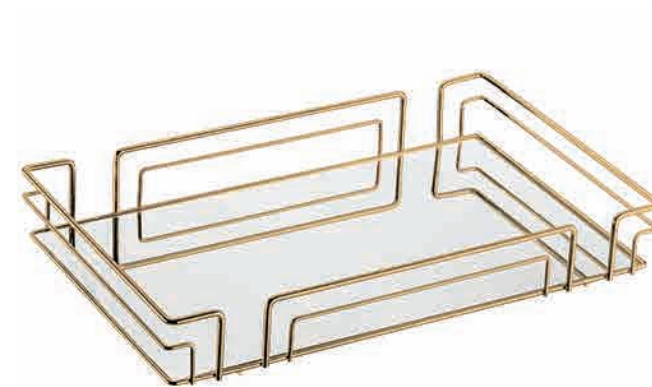

Bandeja Luiza Retangular
 base espelhada
 aramado cromado *
 verniz cataforese **
 embalagem em caixa parda
 caixa master 4 un.

LUIZA RETANGULAR

96



Bandeja Luiza Retangular Black Matte
ref. 1674.20
☐31,5 ☐66,5 ☐8,5

LUIZA RETANGULAR

| | cor | tamanho | referência | código de barras |
|---|-------------|---------------------------|------------|------------------|
|  | black matte | □ 31,5 ▢ 41,5 ⊕ 8,5 | 1672.20 | 7899283515331 |
|  | | □ 31,5 ▢ 51,5 ⊕ 8,5 | 1673.20 | 7899283515379 |
|  | | □ 31,5 ▢ 66,5 ⊕ 8,5 | 1674.20 | 7899283515416 |
|  | champanhe | □ 31,5 ▢ 41,5 ⊕ 8,5 | 1672.26 | 7899283515348 |
|  | | □ 31,5 ▢ 51,5 ⊕ 8,5 | 1673.26 | 7899283515386 |
|  | | □ 31,5 ▢ 66,5 ⊕ 8,5 | 1674.26 | 7899283515423 |

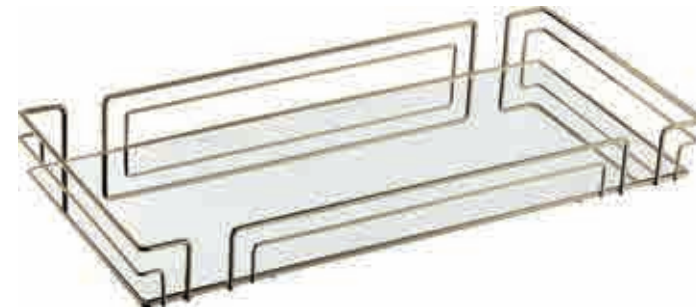

Bandeja Luiza Retangular
 base espelhada
 pintura automotiva
 embalagem em caixa parda
 caixa master 4 un.

WIRE

98



Bandeja Wire Champagne
ref. 1398.26 • 30 40

| | cor | tamanho | referência | código de barras |
|--|-----------|---------|------------|------------------|
|  | champagne | Ø10 ㊦10 | 1395.26 | 7899283513092 |
| | | Ø10 ㊦20 | 1396.26 | 7899283513108 |
| | | Ø15 ㊦25 | 1397.26 | 7899283513115 |
| | | Ø30 ㊦40 | 1398.26 | 7899283513085 |
| | | Ø40 ㊦70 | 1399.26 | 7899283513078 |



Bandeja Wire Champagne
 espelho + aço + pintura automotiva
 embalagem para presente
 caixa master 6 un. (Ø10 ㊦10)
 caixa master 6 un. (Ø10 ㊦20)
 caixa master 4 un. (Ø15 ㊦25)
 caixa master 4 un. (Ø30 ㊦40)
 caixa master 2 un. (Ø40 ㊦70)

WIRE

100



Bandeja Wire Cromada
ref. 1399.23 • 40 70



Bandeja Wire Cromada
ref. 1396.23 • Ø10 120

Bandeja Wire Cromada
ref. 1395.23 • Ø10 120

WIRE

102



Bandeja Wire Cromada
ref. 1397.23 • 15 25

WIRE

| | cor | tamanho | referência | código de barras |
|---|-----|---------|------------|------------------|
|  | | Ø10 @20 | 1396.23 | 7899283509712 |
| | | Ø15 @25 | 1397.23 | 7899283509606 |
| | | Ø30 @40 | 1398.23 | 7899283509422 |
| | | Ø40 @70 | 1399.23 | 7899283510817 |



Bandeja Wire Cromada

espelho + aramado cromado
 embalagem para presente
 caixa master 6 un. (Ø10 @10)
 caixa master 6 un. (Ø10 @20)
 caixa master 4 un. (Ø15 @25)
 caixa master 4 un. (Ø30 @40)
 caixa master 2 un. (Ø40 @70)



Bandeja Wire Golden
ref. 1398.123 • @30 @40



Bandeja Wire Golden
ref. 1397.123 • @15 @25



Bandeja Wire Golden
ref. 1396.123 • @10 @20



Bandeja Wire Golden
ref. 1397.123 • @15 @25

WIRE

| | cor | tamanho | referência | código de barras |
|---|-----|---------|------------|------------------|
|  | | Ø10 ㊦20 | 1396.123 | 7899283509330 |
| | | Ø15 ㊦25 | 1397.123 | 7899283509347 |
| | | Ø30 ㊦40 | 1398.123 | 7899283509323 |
| | | Ø40 ㊦70 | 1399.123 | 7899283510831 |



Bandeja Wire Golden

espelho + verniz cataforese
 embalagem para presente
 caixa master 6 un. (Ø10 ㊦10)
 caixa master 6 un. (Ø10 ㊦20)
 caixa master 4 un. (Ø15 ㊦25)
 caixa master 4 un. (Ø30 ㊦40)
 caixa master 2 un. (Ø40 ㊦70)

WIRE

106



Bandeja Wire Black Matte
ref. 1396.20 • Ø10 20

| | modelo | tamanho | referência | código de barras |
|---|---------|---------|------------|------------------|
|  | espelho | ∅10 ㊦10 | 1395.20 | 7899283510008 |
| | | ∅10 ㊦20 | 1396.20 | 7899283504922 |
| | | ∅15 ㊦25 | 1397.20 | 7899283510015 |
| | | ∅30 ㊦40 | 1398.20 | 7899283505905 |
| | | ∅40 ㊦70 | 1399.20 | 7899283510848 |



Bandeja Wire Black Matte
 espelho + aço + pintura automotiva
 embalagem para presente
 caixa master 6 un. (∅10 ㊦10)
 caixa master 6 un. (∅10 ㊦20)
 caixa master 4 un. (∅15 ㊦25)
 caixa master 4 un. (∅30 ㊦40)
 caixa master 2 un. (∅40 ㊦70)

FENCE ÁGATA GOLDEN

108



Bandeja Fence Ágata Golden Azul
ref. 1602.142 • 15 25

FENCE ÁGATA GOLDEN

| | cor | tamanho | referência | código de barras |
|--|-------|---------|------------|------------------|
|  | preta | Ø10 ㊦20 | 1601.140 | 7899283511869 |
| | | Ø15 ㊦25 | 1602.140 | 7899283511913 |
|  | ambar | Ø10 ㊦20 | 1601.141 | 7899283511876 |
| | | Ø15 ㊦25 | 1602.141 | 7899283511920 |
|  | azul | Ø10 ㊦20 | 1601.142 | 7899283511883 |
| | | Ø15 ㊦25 | 1602.142 | 7899283511937 |
|  | verde | Ø10 ㊦20 | 1601.143 | 7899283511890 |
| | | Ø15 ㊦25 | 1602.143 | 7899283511944 |
|  | rosa | Ø10 ㊦20 | 1601.144 | 7899283511906 |
| | | Ø15 ㊦25 | 1602.144 | 7899283511951 |



Bandeja Fence Ágata Golden

espelho + verniz cataforese + pedra
 embalagem para presente
 caixa master 6 un. (Ø10 ㊦20)
 caixa master 4 un. (Ø15 ㊦25)

LÍVIA

110

Bandeja Lívia Champanhe
ref. 1680.26
□14 □32,5 □5,5

| | cor | tamanho | referência | código de barras |
|--|-------------|------------------------|------------|------------------|
|  | black matte | Ø14 ⊖ 32,5 ⊕ 5,5 | 1680.20 | 7899283514747 |
|  | champanhe | | 1680.26 | 7899283514754 |



Bandeja Livia

barras de aço soldadas com base em chapa perfurada
 pintura automotiva
 embalagem para presente
caixa master 4 un.

LÍVIA ORGANIZADOR

112



Bandeja Lívia Black Matte
ref. 1680.20
Ø14 32,5 5,5



Organizador Lívia Black Matte
ref. 5950.20
Ø14 32,5 21

LÍVIA ORGANIZADOR

| | cor | tamanho | referência | código de barras |
|---|-------------|-----------------------|------------|------------------|
|  | black matte | | 5950.20 | 7899283514723 |
| | | ∅14 ⊖32,5 Ⓜ22,5 | | |
|  | champanhe | | 5950.26 | 7899283514730 |

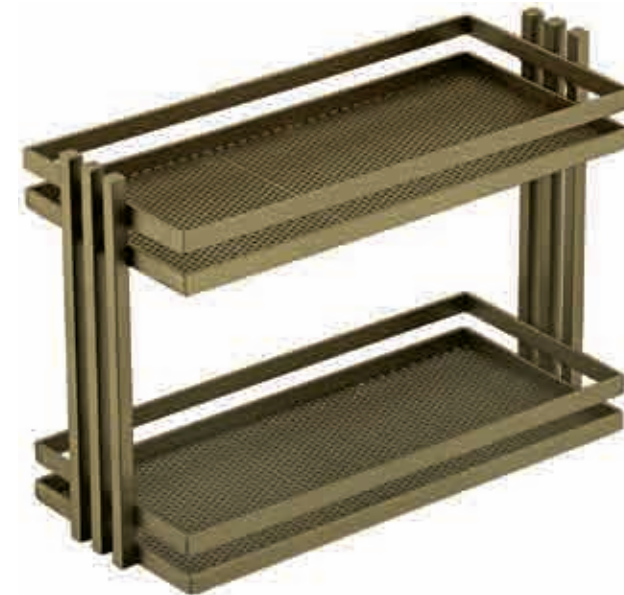

Organizador Livia

barras de aço soldadas com base em chapa perfurada
pintura automotiva
embalagem para presente
caixa master 2 un.





COURO ECOLÓGICO



Bandeja Orgânica Mavie Cinza
ref. 1810.53
Ø25 42 4,5

ORGÂNICA MAVIE

| | cor | tamanho | referência | código de barras |
|--|----------|--------------------|------------|------------------|
|  | preta | ∅25 ∅42 ∅4,5 | 1810.40 | 7899283517304 |
| | | ∅37 ∅62 ∅4,5 | 1811.40 | 7899283517380 |
|  | bege | ∅25 ∅42 ∅4,5 | 1810.51 | 7899283517311 |
| | | ∅37 ∅62 ∅4,5 | 1811.51 | 7899283517397 |
|  | caramelo | ∅25 ∅42 ∅4,5 | 1810.52 | 7899283517328 |
| | | ∅37 ∅62 ∅4,5 | 1811.52 | 7899283517403 |
|  | cinza | ∅25 ∅42 ∅4,5 | 1810.53 | 7899283517335 |
| | | ∅37 ∅62 ∅4,5 | 1811.53 | 7899283517410 |







Bandeja Orgânica Mavie
couro ecológico
lâmina natural de madeira *
embalagem caixa parda
caixa master 4 un.

ORGÂNICA BEATRICE

118

Bandeja Orgânica Beatrice Caramelo
ref. 1815.5251
☐24,5 ☐41 ☐4,5

ORGÂNICA BEATRICE

| | cor | tamanho | referência | código de barras |
|---|--------------------------|----------------------|------------|------------------|
|  | preta costura bege | ☒24,5 ☒41 ☒4,5 | 1815.4051 | 7899283517465 |
| | | ☒36 ☒61 ☒4,5 | 1816.4051 | 7899283517540 |
|  | bege costura preta | ☒24,5 ☒41 ☒4,5 | 1815.5140 | 7899283517489 |
| | | ☒36 ☒61 ☒4,5 | 1816.5140 | 7899283517557 |
|  | caramelo costura bege | ☒24,5 ☒41 ☒4,5 | 1815.5251 | 7899283517496 |
| | | ☒36 ☒61 ☒4,5 | 1816.5251 | 7899283517564 |
|  | cinza costura bege | ☒24,5 ☒41 ☒4,5 | 1815.5351 | 7899283517502 |
| | | ☒36 ☒61 ☒4,5 | 1815.5351 | 7899283517571 |





Bandeja Orgânica Beatrice
couro ecológico
lâmina natural de madeira *
embalagem caixa parda
caixa master 4 un.

ANTONELLA

120



Bandeja Antonella
 couro ecológico
 alças zamak
 embalagem caixa parda
 caixa master 4 un.

| | cor | tamanho | referência | código de barras |
|---|----------|-----------------------|------------|------------------|
|  | preta | Ø 30 ⊕ 55 ⊕ 4,5 | 1822.140 | 7899283517700 |
|  | bege | | 1822.151 | 7899283517717 |
|  | caramelo | | 1822.152 | 7899283517724 |
|  | cinza | | 1822.153 | 7899283517731 |

AURORA

| | cor | tamanho | referência | código de barras |
|--|----------|--------------------|------------|------------------|
|  | preta | | 1820.140 | 7899283517694 |
|  | bege | ∅38 ∅68 ∅4,5 | 1820.151 | 7899283517687 |
|  | caramelo | | 1820.152 | 7899283517670 |



Bandeja Aurora
tampo em couro ecológico
alças zamak + couro ecológico
embalagem caixa parda
caixa master 4 un.





RAPHAELA

122



Bandeja Raphaela Bege
ref. 1800.51
Ø48 80 17

RAPHAELA

| | cor | tamanho | referência | código de barras |
|--|----------|-----------------|------------|------------------|
|  | preto | ∅48 80 17 | 1800.40 | 7899283515539 |
| | | ∅37 65 17 | 1801.40 | 7899283515898 |
| | | ∅34 47 17 | 1802.40 | 7899283515935 |
|  | bege | ∅48 80 17 | 1800.51 | 7899283515553 |
| | | ∅37 65 17 | 1801.51 | 7899283515904 |
| | | ∅34 47 17 | 1802.51 | 7899283515942 |
|  | caramelo | ∅48 80 17 | 1800.52 | 7899283515560 |
| | | ∅37 65 17 | 1801.52 | 7899283515911 |
| | | ∅34 47 17 | 1802.52 | 7899283515959 |
|  | cinza | ∅48 80 17 | 1800.53 | 7899283515546 |
| | | ∅37 65 17 | 1801.53 | 7899283515928 |
| | | ∅34 47 17 | 1802.53 | 7899283515966 |



Bandeja Raphaella
orgânica em couro ecológico
embalagem caixa parda
caixa master 2 un.

ACRÍLICO









SERENA

126

Bandeja Serena Dourada
ref. 1771.10
Ø31.5 50 03.5

SERENA

| | cor | tamanho | espessura acrílico (mm) | referência | código de barras |
|--|---------------|--------------------|-------------------------------|------------|------------------|
|  | cromada | Ø14 20 3 | 8 | 1770 | 7899283516727 |
| | | Ø31,5 50 3,5 | | 1771 | 7899283516765 |
|  | dourada | Ø14 20 3 | | 1770.10 | 7899283516734 |
| | | Ø31,5 50 3,5 | | 1771.10 | 7899283516772 |
|  | black matte | Ø14 20 3 | | 1770.20 | 7899283516741 |
| | | Ø31,5 50 3,5 | | 1771.20 | 7899283516796 |
|  | dourado fosco | Ø14 20 3 | | 1770.30 | 7899283516758 |
| | | Ø31,5 50 3,5 | | 1771.30 | 7899283516789 |



Bandeja Serena
 acrílico cristal
 material 100% virgem
 embalagem caixa parda
 caixa master 4 un.

CAIXA ORGANIZADORA SERENA

128



Caixa Organizadora Serena
ref. 5930.10
20,5 16 12mm

CAIXA ORGANIZADORA SERENA

| | cor | tamanho | espessura acrílico (mm) | referência | código de barras |
|--|----------------|-------------------|-------------------------------|------------|------------------|
|  | cromada | Ø20,5 16 12 | 4 | 5930 | 7899283517786 |
|  | dourada | | | 5930.10 | 7899283517793 |
|  | black matte | | | 5930.20 | 7899283517809 |
|  | dourados fosco | | | 5930.30 | 7899283517816 |



Caixa Organizadora Serena
 acrílico cristal 4 mm
 material 100% virgem
 embalagem caixa parda
 caixa master 4 un.



Bandeja Design
ref. 1707
∅33 ∅42 ∅20mm

| tamanho | espessura acrílico (mm) | referência | código de barras |
|------------|-------------------------|------------|------------------|
| Ø12 ⊞25 | | 1705 | 7899283515072 |
| Ø20 ⊞30 | 20 | 1706 | 7899283515089 |
| Ø33 ⊞42 | | 1707 | 7899283515096 |



Bandeja Design
bandeja em acrílico cristal
material 100% virgem
embalagem em caixa parda
caixa master 4 un.

DOBRADA

132



Bandeja Dobrada
ref. 1710
20 32 4

DOBRADA

| tamanho | espessura acrílico (mm) | referência | código de barras |
|------------------|-------------------------|------------|------------------|
| Ø20 ▣32 Ⓜ4 | | 1710 | 7899283514969 |
| Ø20 ▣42 Ⓜ4 | 6 | 1711 | 7899283514976 |
| Ø33 ▣51 Ⓜ4 | | 1712 | 7899283514983 |



Bandeja Dobrada
bandeja em acrílico cristal
material 100% virgem
embalagem em caixa parda
caixa master 4 un.

DOBRADA BAIXA

134



Bandeja Dobrada Baixa
ref. 1718
☐24 ☐35 ☐3,5

DOBRADA BAIXA

| tamanho | espessura acrílico (mm) | referência | código de barras |
|--------------------|-------------------------|------------|------------------|
| ∅10 ∅35 ∅3,5 | 4 | 1715 | 7899283515010 |
| ∅12 ∅25 ∅3,5 | | 1716 | 7899283515027 |
| ∅20 ∅20 ∅3,5 | | 1717 | 7899283515034 |
| ∅24 ∅35 ∅3,5 | | 1718 | 7899283515041 |



Bandeja Dobrada Baixa

bandeja em acrílico cristal
material 100% virgem
embalagem em caixa parda
caixa master 4 un.

ALÇA LATERAL

136

Bandeja Alça Lateral
ref. 1730
20 30 4

ALÇA LATERAL

| tamanho | espessura acrílico (mm) | referência | código de barras |
|---------------------|-------------------------|------------|------------------|
| ☒ 20 ☒ 30 ☒ 4 | | 1730 | 7899283515058 |
| | 4 | | |
| ☒ 20 ☒ 42 ☒ 4 | | 1731 | 7899283515065 |



Bandeja Alça Lateral
bandeja em acrílico cristal
material 100% virgem
embalagem em caixa parda
caixa master 4 un.

LISA ALTA

138



Bandeja Lisa Alta
ref. 1720
☐23 ☐33 ☐8



Bandeja Lisa Alta
bandeja em acrílico cristal
material 100% virgem
embalagem em caixa parda
caixa master 4 un.

| tamanho | espessura acrílico (mm) | referência | código de barras |
|------------------|-------------------------|------------|------------------|
| ☐23 ☐33 ☐8 | 6 | 1720 | 7899283514990 |
| ☐33 ☐42 ☐8 | | 1721 | 7899283515003 |

LISA BAIXA

| tamanho | espessura acrílico (mm) | referência | código de barras |
|------------------|-------------------------|------------|------------------|
| Ø12 ⊖25 ⊞4 | 6 | 1725 | 7899283515140 |
| Ø20 ⊖30 ⊞4 | | 1726 | 7899283515157 |
| Ø33 ⊖33 ⊞4 | | 1727 | 7899283515164 |
| Ø33 ⊖42 ⊞4 | | 1728 | 7899283515171 |







Bandeja Lisa Baixa
bandeja em acrílico cristal
material 100% virgem
embalagem em caixa parda
caixa master 4 un.

JULIE

140

Bandeja Julie Dourada
ref. 1776.10
Ø33 □42 □5

JULIE

| | cor | tamanho | espessura acrílico (mm) | referência | código de barras |
|--|---------------|-----------------|-------------------------------|------------|------------------|
|  | cromada | Ø20 30 15 | 20 | 1775 | 7899283516802 |
| | | Ø33 42 15 | | 1776 | 7899283516840 |
|  | dourada | Ø20 30 15 | | 1775.10 | 7899283516819 |
| | | Ø33 42 15 | | 1776.10 | 7899283516857 |
|  | black matte | Ø20 30 15 | | 1775.20 | 7899283516826 |
| | | Ø33 42 15 | | 1776.20 | 7899283516864 |
|  | dourado fosco | Ø20 30 15 | | 1775.30 | 7899283516833 |
| | | Ø33 42 15 | | 1776.30 | 7899283516871 |



Bandeja Julie
 acrílico cristal
 material 100% virgem
 embalagem caixa parda
 caixa master 4 un.

LIA

142



Bandeja Lia Black Matte
ref. 1781.20
☐30 ☐48 ☐3

| | cor | tamanho | espessura acrílico (mm) | referência | código de barras |
|--|-------------|----------------|-------------------------------|------------|------------------|
|  | incolor | Ø20 29 3 | 3 | 1780 | 7899283516895 |
| | | Ø30 48 3 | | 1781 | 7899283517885 |
|  | black matte | Ø20 29 3 | | 1780.20 | 7899283516901 |
| | | Ø30 48 3 | | 1781.20 | 7899283517892 |
|  | branca | Ø20 29 3 | | 1780.21 | 7899283516918 |
| | | Ø30 48 3 | | 1781.21 | 7899283517908 |



Bandeja Lia
 acrílico cristal
 material 100% virgem
 embalagem caixa parda
 caixa master 4 un.

PORTA LENÇOS

144





Porta Lenços

porta lenços em acrílico cristal
material 100% virgem
embalagem em caixa parda
caixa master 4 un.

| | cor | tamanho | espessura acrílico (mm) | referência | código de barras |
|--|--------------|------------------|-------------------------|------------|------------------|
|  | transparente | | | 5909 | 7899283511180 |
|  | preto | Ø13 26 8,5 | 3 | 5909.20 | 7899283511197 |
|  | branco | | | 5909.21 | 7899283515188 |

LINHA DE BANHO

| | produto | tamanho | espessura acrílico (mm) | referência | código de barras |
|---|------------------------|--------------------|---|------------|------------------|
|  | porta escova de dentes | | | 5906 | 7899283511104 |
|  | porta sabonete líquido | ☒ 9 ☒ 9 ☒ 12 | 6 (estrutura) 8 (tampa e base) | 5907 | 7899283511128 |
|  | porta algodão | | | 5908 | 7899283511142 |



Linha de Banho
 porta algodão, porta escova de dentes
 e porta sabonete líquido
 em acrílico cristal
 material 100% virgem
 embalagem em caixa parda
caixa master 4 un.

PORTA SABONETE LÍQUIDO

146



Porta Sabonete Líquido
porta sabonete líquido em acrílico cristal
material 100% virgem
embalagem em caixa parda
caixa master 6 un.



cor

tamanho

referência

código de barras

branco

5925.21

7899283515744

Ø9
Ø9
Ø16



preto

5925.20

7899283515737

DIFUSOR

| | cor | tamanho | referência | código de barras |
|--|--------|--------------------|------------|------------------|
|  | branco | | 5926.21 | 7899283515768 |
| | | ☒ 9 ☒ 9 ☒ 13 | | |
|  | preto | | 5926.20 | 7899283515751 |



Difusor
difusor em acrílico cristal
material 100% virgem
embalagem em caixa parda
caixa master 6 un.

BANDEJA

148



Bandeja

bandeja em acrílico cristal
material 100% virgem
embalagem em caixa parda
caixa master 6 un.



branco

1757.21

7899283515782

∅11,5
∅22,5
∅2,5



preto

1757.20

7899283515775

| cor | tamanho | referência | código de barras |
|--------|------------------------|------------|------------------|
| branco | | 1757.21 | 7899283515782 |
| | ∅11,5 ∅22,5 ∅2,5 | | |
| preto | | 1757.20 | 7899283515775 |

| | cor | tamanho | referência | código de barras |
|--|--------|-----------------------|------------|------------------|
|  | branco | | 5927.21 | 7899283515881 |
| | | Ø11,5 □22,5 □16 | | |
|  | preto | | 5927.20 | 7899283515874 |







Kit Sabonete Líquido + Difusor + Bandeja
 em acrílico cristal
 material 100% virgem
 embalagem em caixa parda
 caixa master 4 un.

LIXEIRA





150



Lixeira
 lixeira em acrílico cristal
 material 100% virgem
 embalagem em caixa parda
 caixa master 4 un.

| | cor | tamanho | puxador | referência | código de barras |
|--|--------|------------------|-----------|---------------|------------------|
|  | branco | Ø18 18 128 | padrão | 5922.21 | 7899283515720 |
|  | | crystal dourado | 5922.2111 | 7899283515836 | |
|  | | crystal prata | 5922.215 | 7899283515850 | |
|  | | diamante dourado | 5922.2112 | 7899283515843 | |
|  | | diamante prata | 5922.216 | 7899283515867 | |

LIXEIRA

| | cor | tamanho | puxador | referência | código de barras |
|--|-------|----------------------|------------------|---------------|------------------|
|  | preto | ☑ 18 ☒ 18 ☒ 28 | padrão | 5922.20 | 7899283515706 |
|  | | crystal dourado | 5922.2011 | 7899283515799 | |
|  | | crystal prata | 5922.205 | 7899283515812 | |
|  | | ☑ 18 ☒ 18 ☒ 29 | diamante dourado | 5922.2012 | 7899283515805 |
|  | | diamante prata | 5922.206 | 7899283515829 | |



Lixeira
 lixeira em acrílico cristal
 material 100% virgem
 embalagem em caixa parda
caixa master 4 un.

CAFÉ DA MANHÃ

152



Bandeja Café da Manhã

ref. 1748

☐25 ☐50 ☐30



Bandeja Café da Manhã

bandeja em acrílico cristal
material 100% virgem
embalagem em caixa parda
caixa master 4 un.

| tamanho | espessura acrílico (mm) | referência | código de barras |
|-------------------|-------------------------|------------|------------------|
| ☐25 ☐50 ☐30 | 8 (bandeja) 15 (pés) | 1748 | 7899283515294 |



CARRINHO DE BEBIDAS

Carrinho de Bebidas
ref. 5995
Ø43 60 80

CARRINHO DE BEBIDAS



154

Carrinho de Bebidas
ref. 5995
∅43 ∅60 ∅80



Carrinho de Bebidas
carrinho em acrílico cristal
material 100% virgem
embalagem em caixa parda
caixa master 1 un.

| tamanho | espessura acrílico (mm) | referência | código de barras |
|-------------------|-------------------------|------------|------------------|
| ∅43 ∅60 ∅80 | 6 (bandeja) 20 (pés) | 5995 | 7899283515300 |

GIN BOX



GIN BOX • PORTA CHÁ



Gin Box

gin box em acrílico cristal - material 100% virgem
embalagem em caixa parda - **caixa master 4 un.**



Porta Chá

porta chá em acrílico cristal - material 100% virgem
embalagem em caixa parda - **caixa master 4 un.**

| tamanho | espessura acrílico (mm) | referência | código de barras |
|---------------------|-------------------------|------------|------------------|
| Ø20 Ø13 Ø 5,5 | 6 | 5941 | 7899283515218 |

| tamanho | espessura acrílico (mm) | referência | código de barras |
|--------------------|-------------------------|------------|------------------|
| Ø24 Ø18 Ø 10 | 6 | 5940 | 7899283515195 |

BANDEJA ELEMENTO



Bandeja Elemento

bandeja em acrílico cristal
material 100% virgem
embalagem caixa parda
caixa master 4 un.

| tamanho | espessura acrílico (mm) | referência | código de barras |
|--------------------|-------------------------|------------|------------------|
| Ø12,5 Ø24 Ø3 | 20 | 1735 | 7899283516925 |
| Ø20 Ø30 Ø3 | | 1736 | 7899283518103 |











BANHO

OPEN

160



Suporte Toalha/Papel Open Cromado
ref. 5911 • 18 13 47

| | cor | tamanho | referência | código de barras |
|---|-----------------|-----------|------------|------------------|
|  | cromado * | ∅18 13 47 | 5911 | 7899283509705 |
|  | golden ** | | 5911.10 | 7899283509392 |
|  | black matte *** | | 5911.20 | 7899283510022 |
|  | champagne *** | | 5911.26 | 7899283513566 |



Suporte para Toalha/Papel Open

aramado cromado *
 verniz cataforese **
 pintura automotiva ***
 caixa master 4 un.

OPEN CRYSTAL

162

Suporte para Toalha/Papel
Open Diamante
ref. 5911.12 • @19,5 @13 @47



OPEN CRYSTAL

| | cor | tamanho | referência | código de barras |
|---|-----------------|---------------|------------|------------------|
|  | cromado * | | 5911.5 | 7899283513337 |
|  | golden ** | Ø19,5 @13 @47 | 5911.11 | 7899283513344 |
|  | black matte *** | | 5911.205 | 7899283513993 |



Suporte para Toalha/Papel Open Crystal

aramado cromado *
 verniz cataforese **
 pintura automotiva ***
 caixa master 4 un.





ANY

164



Suporte para Toalha
Any Cromado
ref. 5917 • 022 012 028



| | cor | tamanho | referência | código de barras |
|---|-----------------|-----------|------------|------------------|
|  | cromado * | ∅22 12 28 | 5917 | 7899283510428 |
|  | golden ** | | 5917.10 | 7899283510442 |
|  | black matte *** | | 5917.20 | 7899283511746 |
|  | champagne *** | | 5917.26 | 7899283513573 |



Suporte para Toalha Any





aramado cromado *
verniz cataforese **
pintura automotiva ***
caixa master 6 un.

ANY

166

Papeleira de Chão Any Cromado

ref. 5918 • Ø15 16 49
aramado cromado *
verniz cataforese **
pintura automotiva ***
embalagem p/ presente
caixa master 6 un.

| | cor | tamanho | referência | código de barras |
|---|-----------------|-----------|------------|------------------|
|  | cromado * | | 5918 | 7899283510701 |
|  | golden ** | | 5918.10 | 7899283510718 |
|  | black matte *** | Ø15 16 49 | 5918.20 | 7899283511678 |
|  | champagne *** | | 5918.26 | 7899283513634 |

MINIBANHEIRAS

| | cor | tamanho | referência | código de barras |
|---|---|-----------------|------------|------------------|
|  | transparente | Ø7 13 16 | 1590 | 7899283510565 |
|  | preta | | 1590.20 | 7899283510572 |
|  | branca | | 1590.21 | 7899283510589 |
|  | * opção de personalização em todas as cores | | 1590.P | 7899283510626 |
|  | transparente | Ø13 25 13 | 1591 | 7899283510596 |
|  | preta | | 1591.20 | 7899283510602 |
|  | branca | | 1591.21 | 7899283510619 |
|  | * opção de personalização em todas as cores | | 1591.P | 7899283510633 |

* consultar regras de personalização



Minibanheira Branca

poliestireno
caixa master 12 un.

| tamanho | referência | código de barras |
|-----------------|------------|------------------|
| Ø13 25 13 | 1591.21 | 7899283510619 |

ÁGATA











ÁGATA

170



Difusor de Aromas Ágata
pedra ágata
* varetas não acompanham o produto

| | cor | referência | código de barras |
|---|--------|------------|------------------|
|  | branco | 7000 | 7899283512088 |
|  | preto | 7000.40 | 7899283512095 |
|  | verde | 7000.43 | 7899283512101 |
|  | rosa | 7000.44 | 7899283512118 |

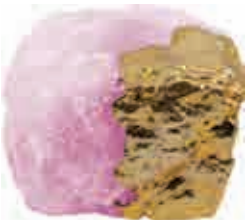
| | cor | referência | código de barras |
|---|--------|------------|------------------|
|  | branco | 7001.10 | 7899283512125 |
|  | preto | 7001.140 | 7899283512132 |
|  | verde | 7001.143 | 7899283512149 |
|  | rosa | 7001.144 | 7899283512156 |



Porta Velas Ágata
pedra ágata

ÁGATA

172



Bandeja Ágata para Difusor
caixa master 6 un.

| | cor | referência | código de barras |
|---|-------|------------|------------------|
|  | preto | 7002.140 | 7899283512415 |
|  | ambar | 7002.141 | 7899283512422 |
|  | azul | 7002.142 | 7899283512439 |
|  | verde | 7002.143 | 7899283512446 |
|  | rosa | 7002.144 | 7899283512453 |

| | cor | referência | código de barras |
|--|-------|------------|------------------|
|  | preto | 7005.140 | 7899283512163 |
|  | ambar | 7005.141 | 7899283512170 |
|  | azul | 7005.142 | 7899283512187 |
|  | verde | 7005.143 | 7899283512194 |
|  | rosa | 7005.144 | 7899283512200 |







Kit Porta Garrafa + Stopper Wine
pedra ágata



Kit 6 Porta Copos
pedra ágata com borda dourada

| | cor | referência | código de barras |
|---|-------|------------|------------------|
|  | preto | 7006.140 | 7899283512262 |
|  | ambar | 7006.141 | 7899283512279 |
|  | azul | 7006.142 | 7899283512286 |
|  | verde | 7006.143 | 7899283512293 |
|  | rosa | 7006.144 | 7899283512309 |

| | cor | referência | código de barras |
|---|-------|------------|------------------|
|  | preto | 7007.140 | 7899283012311 |
|  | ambar | 7007.141 | 7899283512347 |
|  | azul | 7007.142 | 7899283512323 |
|  | verde | 7007.143 | 7899283512330 |
|  | rosa | 7007.144 | 7899283512354 |



Kit 6 Anéis Guardanapo
pedra ágata com borda dourada





FONDUE

BARCELONA

178



Réchaud Barcelona
com Pedra Sabão
ref. 6003



Réchaud Barcelona

aramado + bandeja aço inox + queimadores · caixa master 2 un.

| modelo | tamanho | referência | código de barras |
|---------------|-------------|------------|------------------|
| 2 queimadores | ☒29 ☒43 ☒10 | 6000 | 7899283500153 |

aramado (não acompanha queimadores) · caixa master 6 un.

| modelo | tamanho | referência | código de barras |
|--------------------------|--------------|------------|------------------|
| aramado 2 queimadores | ☒23 ☒33,2 ☒9 | 6006 | |



Réchaud Barcelona com Pedra Sabão (Fondue na Pedra)

aramado + bandeja aço inox + queimadores +
pedra sabão · caixa master 2 un.

Ideal para o preparo de carnes e legumes.

| modelo | tamanho | referência | código de barras |
|---------------|-------------|------------|------------------|
| 2 queimadores | ☒29 ☒43 ☒14 | 6003 | 7899283500238 |



Acendedor para Réchaud

8 pastilhas de álcool
caixa master 12 un.

Combustível ideal para todos os tipos de réchaud,
especialmente os réchauds Hara com Pedra Sabão.
Chama com alto poder calorífico.
Prático e seguro.

| referência | código de barras |
|------------|------------------|
| 6200 | 7899283503420 |

VICENZA

180

Réchaud Vicenza
com Pedra Sabão
ref. 6164





**Réchaud Vicenza com Pedra Sabão
2 Queimadores (Fondue na Pedra)**

suporte em piatina + bandeja aço inox +
queimadores + pedra sabão
caixa master 2 un.

Ideal para o preparo de carnes e legumes.

| tamanho | referência | código de barras |
|-------------|------------|------------------|
| ∅29 ∅43 ∅14 | 6164 | 7899283502720 |



Réchaud Vicenza com Bandeja

suporte em piatina + bandeja aço inox + queimadores
caixa master 2 un.

| modelo | tamanho | referência | código de barras |
|---------------|-------------|------------|------------------|
| 2 queimadores | ∅29 ∅43 ∅10 | 6162 | 7899283502706 |



Réchaud Redondo Vicenza
suporte em piaquina + queimador
caixa master 2 un.

Não acompanha tigela de vidro.

| modelo | tamanho | referência | código de barras |
|-------------|---------|------------|------------------|
| 1 queimador | Ø10 @29 | 6170 | 7899283502737 |



**Réchaud Redondo Vicenza
com Pedra Sabão**
suporte em piaquina + queimador + pedra sabão
caixa master 2 un.

| tamanho | referência | código de barras |
|---------|------------|------------------|
| Ø12 @29 | 6174 | 7899283502751 |



**Aquecedor para Réchaud
Álcool Gel/Pastilha**
aço inox
caixa master 6 un.

| tamanho | referência | código de barras |
|---------|------------|------------------|
| Ø10 | 6100 | 7899283500221 |



Pedra Sabão Redonda para Réchaud Vicenza

pedra sabão com friso
caixa master 2 un.

| tamanho | referência | código de barras |
|-----------|------------|------------------|
| 12,5 @ 29 | 6175 | 7899283503055 |



Pedra Sabão Retangular para Réchaud Vicenza

pedra sabão com friso
caixa master 2 un.

| modelo | tamanho | referência | código de barras |
|--------------|------------------|------------|------------------|
| 2queimadores | 20,2 @ 31,2 12,5 | 6165 | 7899283503048 |



Pedra Sabão Retangular para Réchaud Barcelona

pedra sabão com friso
caixa master 2 un.

| tamanho | referência | código de barras |
|--------------|------------|------------------|
| 22 @ 33 12,5 | 6002 | 7899283500191 |

OUTLET





LUIZA

186

Bandeja Luiza Champanhe
ref. 1670.26
30 8,5



| | cor | tamanho | referência | código de barras |
|--|-----------------|---------------|------------|------------------|
|  | cromada * | Ø 30 H 8,5 | 1670 | 7899283514600 |
| | | Ø 45 H 8,5 | 1671 | 7899283514648 |
|  | golden ** | Ø 30 H 8,5 | 1670.10 | 7899283514617 |
| | | Ø 45 H 8,5 | 1671.10 | 7899283514631 |
|  | black matte *** | Ø 30 H 8,5 | 1670.20 | 7899283514624 |
| | | Ø 45 H 8,5 | 1671.20 | 7899283514655 |
|  | champagne *** | Ø 30 H 8,5 | 1670.26 | 7899283514709 |
| | | Ø 45 H 8,5 | 1671.26 | 7899283514716 |

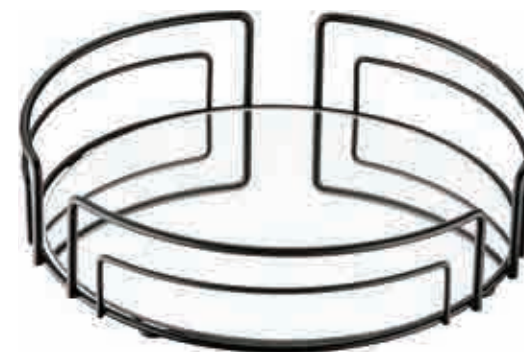

Bandeja Luiza
 base espelhada
 aramado cromado *
 verniz cataforese **
 pintura automotiva ***
 embalagem para presente
 caixa master 4 un.

ÂNGULO

188



Bandeja Angulo Cromada
ref. 1611 • Ø10 28

Bandeja Angulo Cromada
ref. 1610 • Ø10 20



Bandeja Angulo Cromada

espelho + aramado cromado
 embalagem para presente
 caixa master 6 un. (∅10 20)
 caixa master 4 un. (∅10 28)
 caixa master 4 un. (∅15 25)



Bandeja Angulo Golden

espelho + verniz cataforese
 embalagem para presente
 caixa master 6 un. (∅10 20)
 caixa master 4 un. (∅10 28)
 caixa master 4 un. (∅15 25)

| | tamanho | referência | código de barras |
|---|---------|------------|------------------|
|  | ∅10 20 | 1610 | 7899283506919 |
| | ∅15 25 | 1612 | 7899283506896 |

| | tamanho | referência | código de barras |
|---|---------|------------|------------------|
|  | ∅10 20 | 1610.10 | 7899283506636 |
| | ∅15 25 | 1612.10 | 7899283506612 |



Bandeja Vivi Cromada
ref. 1.631 • 15x25

| | cor | tamanho | referência | código de barras |
|--|----------|---------|------------|------------------|
|  | cromada | Ø10 @20 | 1.630 | 7899283510756 |
| | | Ø15 @25 | 1.631 | 7899283510787 |
|  | * golden | Ø10 @20 | 1630.10 | 7899283510770 |
| | | Ø15 @25 | 1631.10 | 7899283510800 |



Bandeja Vivi

espelho + aramado cromado ou * verniz cataforese
 embalagem para presente
caixa master 6 un. (Ø10 @20)
caixa master 4 un. (Ø15 @25)

ANY

192



Bandeja Any Cromada
ref. 1620.10 • Ø10 20

| | cor | tamanho | referência | código de barras |
|---|----------|---------|------------|------------------|
|  | cromada | ∅10 @20 | 1620 | 7899283510305 |
| | | ∅15 @25 | 1621 | 7899283510343 |
|  | golden * | ∅10 @20 | 1620.10 | 7899283510312 |

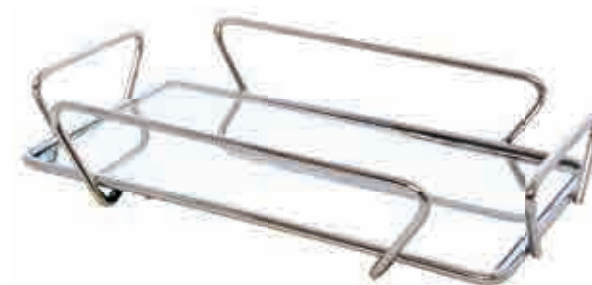

Bandeja Any



espelho + aramado cromado ou verniz cataforese *
 embalagem para presente
 caixa master 6 un. (∅10 @20)
 caixa master 4 un. (∅15 @25)
 caixa master 4 un. (∅30 @40)

VITRA

194



Bandeja Vitra Incolor
ref. 1300 • 230 40

| | cor | tamanho | referência | código de barras |
|---|-----------|---------|------------|------------------|
|  | * incolor | Ø30 ㊦40 | 1300 | 7899283500054 |
| | | Ø20 ㊦30 | 1320 | 7899283500757 |
|  | * preta | Ø30 ㊦40 | 1301 | 7899283500269 |
| | | Ø20 ㊦30 | 1321 | 7899283500764 |
|  | espelho | Ø30 ㊦40 | 1305 | 7899283501068 |
| | | Ø20 ㊦30 | 1325 | 7899283501082 |



Bandeja Vitra

* vidro temperado + pátina cromada
 embalagem para presente
 caixa master 4 un.

WINGS

196



Bandeja Wings
ref. 1372 • 15 25

WINGS

197

Bandeja Wings
ref. 1373 • 30 40

WINGS



Bandeja Wings Cromada

* vidro temperado + aramado cromado
 embalagem para presente
 caixa master 4 un.

| | cor | tamanho | referência | código de barras |
|---|-----------|---------|------------|------------------|
|  | * incolor | ∅15 □25 | 1372 | 7899283503543 |
| | | ∅30 □40 | 1373 | 7899283503574 |
|  | * preta | ∅30 □40 | 1373.20 | 7899283503581 |
|  | espelho | ∅15 □25 | 1372.23 | 7899283503567 |
| | | ∅30 □40 | 1373.23 | 7899283503598 |



Bandeja Wings Golden

* vidro temperado + aço inox metalizado
 embalagem para presente
 caixa master 4 un.

| | cor | tamanho | referência | código de barras |
|---|-----------|---------|------------|------------------|
|  | * incolor | ∅15 ㊦25 | 1372.10 | 7899283507633 |
| | | ∅30 ㊦40 | 1373.10 | 7899283510466 |
|  | * preta | ∅30 ㊦40 | 1373.120 | 7899283507596 |
|  | espelho | ∅15 ㊦25 | 1372.123 | 7899283510640 |
| | | ∅30 ㊦40 | 1373.123 | 7899283507589 |

GRETHA

200



Bandeja Gretha Golden
ref. 1650.10 • 22,5 22,5

GRETHA

| | cor | tamanho | referência | código de barras |
|--|-----------------|---------------|------------|------------------|
|  | cromada * | Ø22,5 22,5 | 1650 | 7899283511609 |
| | | Ø35,5 35,5 | 1651 | 7899283511630 |
|  | golden ** | Ø22,5 22,5 | 1650.10 | 7899283511616 |
| | | Ø35,5 35,5 | 1651.10 | 7899283511647 |
|  | black matte *** | Ø35,5 35,5 | 1651.20 | 7899283511999 |



Bandeja Gretha
 espelho
 aramado cromado *
 verniz cataforese **
 pintura automotiva ***
 embalagem parda
 caixa master 6 un.

TWIST

202



**Réchaud Twist
para Queijo Brie**
ref. 6184



Réchaud Twist para Queijo Brie
suporte em piatina + prato em cerâmica +
placa difusora de alumínio + suporte para vela + vela
caixa master 2 un.

| modelo | tamanho | referência | código de barras |
|--------------|---------|------------|------------------|
| sem espátula | Ø19 @16 | 6184 | 7899283507640 |
| com espátula | | 6185 | 7899283507657 |

Haradecor Ind. e Com. de Utilidades e Decorações Ltda.

Rua Catarina Zanrosso, 179 • Bairro Planalto

Caxias do Sul • RS • CEP 95080-060

📞 54 99610.8270 🌐 haradecor 🌐 haradecor.com.br

